

O'REILLY®



# Learning TensorFlow

---

A GUIDE TO BUILDING DEEP LEARNING SYSTEMS

Tom Hope, Yehezkel S. Resheff & Itay Lieder

# Learning TensorFlow

Roughly inspired by the human brain, deep neural networks trained with large amounts of data can solve complex tasks with unprecedented accuracy. This practical book provides an end-to-end guide to TensorFlow, the leading open source software library that helps you build and train neural networks for computer vision, natural language processing (NLP), speech recognition, and general predictive analytics.

Authors Tom Hope, Yehezkel Resheff, and Itay Lieder provide a hands-on approach to TensorFlow fundamentals for a broad technical audience—from data scientists and engineers to students and researchers. You'll begin by working through some basic examples in TensorFlow before diving deeper into topics such as neural network architectures, TensorBoard visualization, TensorFlow abstraction libraries, and multithreaded input pipelines. Once you finish this book, you'll know how to build and deploy production-ready deep learning systems in TensorFlow.

- Get up and running with TensorFlow rapidly and painlessly
- Learn how to use TensorFlow to build deep learning models from the ground up
- Train popular deep learning models for computer vision and NLP
- Use extensive abstraction libraries to make development easier and faster
- Learn how to scale TensorFlow and use clusters to distribute model training
- Deploy TensorFlow in a production setting

---

**Tom Hope** is an applied machine learning researcher and data scientist with extensive backgrounds in academia and industry. He's led data science and deep learning R&D efforts across multiple domains.

**Yehezkel S. Resheff** is an applied data-science researcher. His PhD work was centered around machine learning and deep learning methods for wearable devices and the IoT. He formerly led deep learning R&D initiatives at Intel and Microsoft.

**Itay Lieder** is an applied researcher in machine learning and computational neuroscience. During his graduate work, he developed computational methods for modeling low-level perception. He's led innovative deep learning R&D efforts in text analytics and web mining at large international corporations.

US \$49.99

CAN \$65.99

ISBN: 978-1-491-97851-1



5 4 9 9 9



Twitter: @oreillymedia  
facebook.com/oreilly

---

# Learning TensorFlow

*A Guide to Building Deep Learning Systems*

*Tom Hope, Yehezkel S. Resheff, and Itay Lieder*

Beijing • Boston • Farnham • Sebastopol • Tokyo

**O'REILLY**<sup>®</sup>

## Learning TensorFlow

by Tom Hope, Yehezkel S. Resheff, and Itay Lieder

Copyright © 2017 Tom Hope, Itay Lieder, and Yehezkel S. Resheff. All rights reserved.

Printed in the United States of America.

Published by O'Reilly Media, Inc., 1005 Gravenstein Highway North, Sebastopol, CA 95472.

O'Reilly books may be purchased for educational, business, or sales promotional use. Online editions are also available for most titles (<http://oreilly.com/safari>). For more information, contact our corporate/institutional sales department: 800-998-9938 or [corporate@oreilly.com](mailto:corporate@oreilly.com).

**Editor:** Nicole Tache

**Production Editor:** Shiny Kalapurakkel

**Copyeditor:** Rachel Head

**Proofreader:** Sharon Wilkey

**Indexer:** Judith McConville

**Interior Designer:** David Futato

**Cover Designer:** Karen Montgomery

**Illustrator:** Rebecca Demarest

August 2017: First Edition

### Revision History for the First Edition

2017-08-04: First Release

2017-09-15: Second Release

The O'Reilly logo is a registered trademark of O'Reilly Media, Inc. *Learning TensorFlow*, the cover image, and related trade dress are trademarks of O'Reilly Media, Inc.

While the publisher and the authors have used good faith efforts to ensure that the information and instructions contained in this work are accurate, the publisher and the authors disclaim all responsibility for errors or omissions, including without limitation responsibility for damages resulting from the use of or reliance on this work. Use of the information and instructions contained in this work is at your own risk. If any code samples or other technology this work contains or describes is subject to open source licenses or the intellectual property rights of others, it is your responsibility to ensure that your use thereof complies with such licenses and/or rights.

978-1-491-97851-1

[LSI]



---

# Table of Contents

<b>Preface.....</b>	<b>vii</b>
<b>1. Introduction.....</b>	<b>1</b>
Going Deep	1
Using TensorFlow for AI Systems	2
TensorFlow: What's in a Name?	5
A High-Level Overview	6
Summary	8
<b>2. Go with the Flow: Up and Running with TensorFlow.....</b>	<b>9</b>
Installing TensorFlow	9
Hello World	11
MNIST	13
Softmax Regression	14
Summary	21
<b>3. Understanding TensorFlow Basics.....</b>	<b>23</b>
Computation Graphs	23
What Is a Computation Graph?	23
The Benefits of Graph Computations	24
Graphs, Sessions, and Fetches	24
Creating a Graph	25
Creating a Session and Running It	26
Constructing and Managing Our Graph	27
Fetches	29
Flowing Tensors	30
Nodes Are Operations, Edges Are Tensor Objects	30
Data Types	32

Tensor Arrays and Shapes	33
Names	37
Variables, Placeholders, and Simple Optimization	38
Variables	38
Placeholders	39
Optimization	40
Summary	49
<b>4. Convolutional Neural Networks.....</b>	<b>51</b>
Introduction to CNNs	51
MNIST: Take II	53
Convolution	54
Pooling	56
Dropout	57
The Model	57
CIFAR10	61
Loading the CIFAR10 Dataset	62
Simple CIFAR10 Models	64
Summary	68
<b>5. Text I: Working with Text and Sequences, and TensorBoard Visualization.....</b>	<b>69</b>
The Importance of Sequence Data	69
Introduction to Recurrent Neural Networks	70
Vanilla RNN Implementation	72
TensorFlow Built-in RNN Functions	82
RNN for Text Sequences	84
Text Sequences	84
Supervised Word Embeddings	88
LSTM and Using Sequence Length	89
Training Embeddings and the LSTM Classifier	91
Summary	93
<b>6. Text II: Word Vectors, Advanced RNN, and Embedding Visualization.....</b>	<b>95</b>
Introduction to Word Embeddings	95
Word2vec	97
Skip-Grams	98
Embeddings in TensorFlow	100
The Noise-Contrastive Estimation (NCE) Loss Function	101
Learning Rate Decay	101
Training and Visualizing with TensorBoard	102
Checking Out Our Embeddings	103
Pretrained Embeddings, Advanced RNN	105

Pretrained Word Embeddings	106
Bidirectional RNN and GRU Cells	110
Summary	112
<b>7. TensorFlow Abstractions and Simplifications.....</b>	<b>113</b>
Chapter Overview	113
High-Level Survey	115
contrib.learn	117
Linear Regression	118
DNN Classifier	120
FeatureColumn	123
Homemade CNN with contrib.learn	128
TFLearn	131
Installation	131
CNN	131
RNN	134
Keras	136
Pretrained models with TF-Slim	143
Summary	151
<b>8. Queues, Threads, and Reading Data.....</b>	<b>153</b>
The Input Pipeline	153
TFRecords	154
Writing with TFRecordWriter	155
Queues	157
Enqueuing and Dequeuing	157
Multithreading	159
Coordinator and QueueRunner	160
A Full Multithreaded Input Pipeline	162
tf.train.string_input_producer() and tf.TFRecordReader()	164
tf.train.shuffle_batch()	164
tf.train.start_queue_runners() and Wrapping Up	165
Summary	166
<b>9. Distributed TensorFlow.....</b>	<b>167</b>
Distributed Computing	167
Where Does the Parallelization Take Place?	168
What Is the Goal of Parallelization?	168
TensorFlow Elements	169
tf.app.flags	169
Clusters and Servers	170
Replicating a Computational Graph Across Devices	171

Managed Sessions	171
Device Placement	172
Distributed Example	173
Summary	179
<b>10. Exporting and Serving Models with TensorFlow.....</b>	<b>181</b>
Saving and Exporting Our Model	181
Assigning Loaded Weights	182
The Saver Class	185
Introduction to TensorFlow Serving	191
Overview	192
Installation	193
Building and Exporting	194
Summary	201
<b>A. Tips on Model Construction and Using TensorFlow Serving.....</b>	<b>203</b>
<b>Index.....</b>	<b>221</b>

---

# Preface

Deep learning has emerged in the last few years as a premier technology for building intelligent systems that learn from data. Deep neural networks, originally roughly inspired by how the human brain learns, are trained with large amounts of data to solve complex tasks with unprecedented accuracy. With open source frameworks making this technology widely available, it is becoming a must-know for anybody involved with big data and machine learning.

TensorFlow is currently the leading open source software for deep learning, used by a rapidly growing number of practitioners working on computer vision, natural language processing (NLP), speech recognition, and general predictive analytics.

This book is an end-to-end guide to TensorFlow designed for data scientists, engineers, students, and researchers. The book adopts a hands-on approach suitable for a broad technical audience, allowing beginners a gentle start while diving deep into advanced topics and showing how to build production-ready systems.

In this book you will learn how to:

1. Get up and running with TensorFlow, rapidly and painlessly.
2. Use TensorFlow to build models from the ground up.
3. Train and understand popular deep learning models for computer vision and NLP.
4. Use extensive abstraction libraries to make development easier and faster.
5. Scale up TensorFlow with queuing and multithreading, training on clusters, and serving output in production.
6. And much more!

This book is written by data scientists with extensive R&D experience in both industry and academic research. The authors take a hands-on approach, combining practical and intuitive examples, illustrations, and insights suitable for practitioners seeking to build production-ready systems, as well as readers looking to learn to understand and build flexible and powerful models.

# Prerequisites

This book assumes some basic Python programming know-how, including basic familiarity with the scientific library NumPy.

Machine learning concepts are touched upon and intuitively explained throughout the book. For readers who want to gain a deeper understanding, a reasonable level of knowledge in machine learning, linear algebra, calculus, probability, and statistics is recommended.

# Conventions Used in This Book

The following typographical conventions are used in this book:

## *Italic*

Indicates new terms, URLs, email addresses, filenames, and file extensions.

## Constant width

Used for program listings, as well as within paragraphs to refer to program elements such as variable or function names, databases, data types, environment variables, statements, and keywords.

## **Constant width bold**

Shows commands or other text that should be typed literally by the user.

## *Constant width italic*

Shows text that should be replaced with user-supplied values or by values determined by context.

# Using Code Examples

Supplemental material (code examples, exercises, etc.) is available for download at <https://github.com/Hezi-Resheff/Oreilly-Learning-TensorFlow>.

This book is here to help you get your job done. In general, if example code is offered with this book, you may use it in your programs and documentation. You do not need to contact us for permission unless you're reproducing a significant portion of the code. For example, writing a program that uses several chunks of code from this book does not require permission. Selling or distributing a CD-ROM of examples from O'Reilly books does require permission. Answering a question by citing this book and quoting example code does not require permission. Incorporating a significant amount of example code from this book into your product's documentation does require permission.

We appreciate, but do not require, attribution. An attribution usually includes the title, author, publisher, and ISBN. For example: “*Learning TensorFlow* by Tom Hope,



Yehezkel S. Resheff, and Itay Lieder (O'Reilly). Copyright 2017 Tom Hope, Itay Lieder, and Yehezkel S. Resheff, 978-1-491-97851-1.”

If you feel your use of code examples falls outside fair use or the permission given above, feel free to contact us at [permissions@oreilly.com](mailto:permissions@oreilly.com).

## O'Reilly Safari

 **Safari**<sup>®</sup> *Safari* (formerly Safari Books Online) is a membership-based training and reference platform for enterprise, government, educators, and individuals.

Members have access to thousands of books, training videos, Learning Paths, interactive tutorials, and curated playlists from over 250 publishers, including O'Reilly Media, Harvard Business Review, Prentice Hall Professional, Addison-Wesley Professional, Microsoft Press, Sams, Que, Peachpit Press, Adobe, Focal Press, Cisco Press, John Wiley & Sons, Syngress, Morgan Kaufmann, IBM Redbooks, Packt, Adobe Press, FT Press, Apress, Manning, New Riders, McGraw-Hill, Jones & Bartlett, and Course Technology, among others.

For more information, please visit <http://oreilly.com/safari>.

## How to Contact Us

Please address comments and questions concerning this book to the publisher:

O'Reilly Media, Inc.  
1005 Gravenstein Highway North  
Sebastopol, CA 95472  
800-998-9938 (in the United States or Canada)  
707-829-0515 (international or local)  
707-829-0104 (fax)

We have a web page for this book, where we list errata, examples, and any additional information. You can access this page at <http://bit.ly/learning-tensorflow>.

To comment or ask technical questions about this book, send email to [bookquestions@oreilly.com](mailto:bookquestions@oreilly.com).

For more information about our books, courses, conferences, and news, see our website at <http://www.oreilly.com>.

Find us on Facebook: <http://facebook.com/oreilly>

Follow us on Twitter: <http://twitter.com/oreillymedia>

Watch us on YouTube: <http://www.youtube.com/oreillymedia>

## Acknowledgments

The authors would like to thank the reviewers who offered feedback on this book: Chris Fregly, Marvin Bertin, Oren Sar Shalom, and Yoni Lavi. We would also like to thank Nicole Tache and the O'Reilly team for making it a pleasure to write the book.

Of course, thanks to all the people at Google without whom TensorFlow would not exist.

# Introduction

This chapter provides a high-level overview of TensorFlow and its primary use: implementing and deploying deep learning systems. We begin with a very brief introductory look at deep learning. We then present TensorFlow, showcasing some of its exciting uses for building machine intelligence, and then lay out its key features and properties.

## Going Deep

From large corporations to budding startups, engineers and data scientists are collecting huge amounts of data and using machine learning algorithms to answer complex questions and build intelligent systems. Wherever one looks in this landscape, the class of algorithms associated with deep learning have recently seen great success, often leaving traditional methods in the dust. Deep learning is used today to understand the content of images, natural language, and speech, in systems ranging from mobile apps to autonomous vehicles. Developments in this field are taking place at breakneck speed, with deep learning being extended to other domains and types of data, like complex chemical and genetic structures for drug discovery and high-dimensional medical records in public healthcare.

Deep learning methods—which also go by the name of deep neural networks—were originally roughly inspired by the human brain’s vast network of interconnected neurons. In deep learning, we feed millions of data instances into a network of neurons, teaching them to recognize patterns from raw inputs. The deep neural networks take raw inputs (such as pixel values in an image) and transform them into useful representations, extracting higher-level features (such as shapes and edges in images) that capture complex concepts by combining smaller and smaller pieces of information to solve challenging tasks such as image classification ([Figure 1-1](#)). The networks automatically learn to build abstract representations by adapting and correcting them-

selves, fitting patterns observed in the data. The ability to automatically construct data representations is a key advantage of deep neural nets over conventional machine learning, which typically requires domain expertise and manual feature engineering before any “learning” can occur.

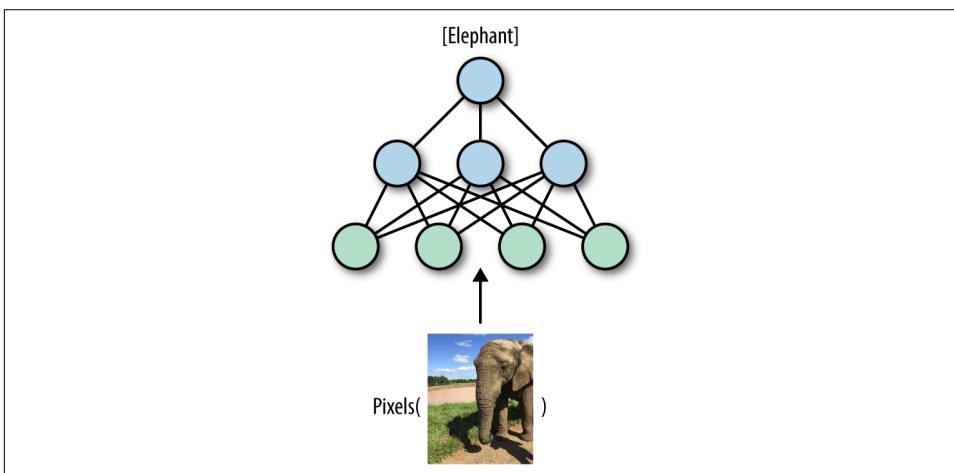

*Figure 1-1. An illustration of image classification with deep neural networks. The network takes raw inputs (pixel values in an image) and learns to transform them into useful representations, in order to obtain an accurate image classification.*

This book is about Google’s framework for deep learning, TensorFlow. Deep learning algorithms have been used for several years across many products and areas at Google, such as search, translation, advertising, computer vision, and speech recognition. TensorFlow is, in fact, a second-generation system for implementing and deploying deep neural networks at Google, succeeding the DistBelief project that started in 2011.

TensorFlow was released to the public as an open source framework with an Apache 2.0 license in November 2015 and has already taken the industry by storm, with adoption going far beyond internal Google projects. Its scalability and flexibility, combined with the formidable force of Google engineers who continue to maintain and develop it, have made TensorFlow the leading system for doing deep learning.

## Using TensorFlow for AI Systems

Before going into more depth about what TensorFlow is and its key features, we will briefly give some exciting examples of how TensorFlow is used in some cutting-edge real-world applications, at Google and beyond.

## Pre-trained models: state-of-the-art computer vision for all

One primary area where deep learning is truly shining is computer vision. A fundamental task in computer vision is image classification—building algorithms and systems that receive images as input, and return a set of categories that best describe them. Researchers, data scientists, and engineers have designed advanced deep neural networks that obtain highly accurate results in understanding visual content. These deep networks are typically trained on large amounts of image data, taking much time, resources, and effort. However, in a growing trend, researchers are publicly releasing pre-trained models—deep neural nets that are already trained and that users can download and apply to their data (Figure 1-2).

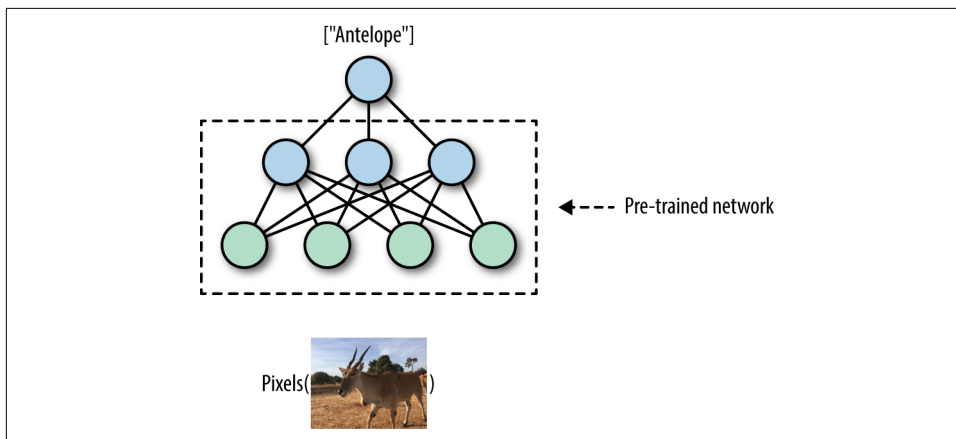

Figure 1-2. Advanced computer vision with pre-trained TensorFlow models.

TensorFlow comes with useful utilities allowing users to obtain and apply cutting-edge pretrained models. We will see several practical examples and dive into the details throughout this book.

## Generating rich natural language descriptions for images

One exciting area of deep learning research for building machine intelligence systems is focused on generating natural language descriptions for visual content (Figure 1-3). A key task in this area is image captioning—teaching the model to output succinct and accurate captions for images. Here too, advanced pre-trained TensorFlow models that combine natural language understanding with computer vision are available.



A Zebra stands by a vehicle in a safari.

*Figure 1-3. Going from images to text with image captioning (illustrative example).*

### **Text summarization**

Natural language understanding (NLU) is a key capability for building AI systems. Tremendous amounts of text are generated every day: web content, social media, news, emails, internal corporate correspondences, and many more. One of the most sought-after abilities is to summarize text, taking long documents and generating succinct and coherent sentences that extract the key information from the original texts (Figure 1-4). As we will see later in this book, TensorFlow comes with powerful features for training deep NLU networks, which can also be used for automatic text summarization.



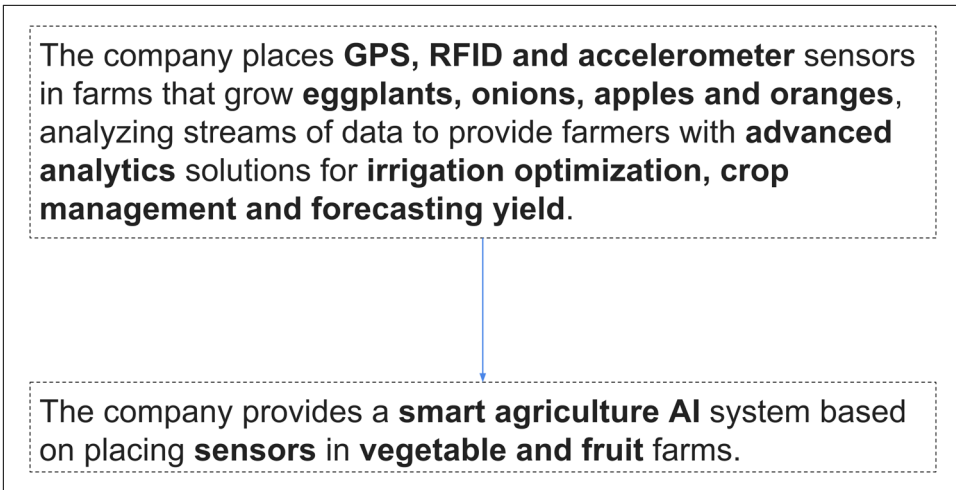

Figure 1-4. An illustration of smart text summarization.

## TensorFlow: What's in a Name?

Deep neural networks, as the term and the illustrations we've shown imply, are all about networks of neurons, with each neuron learning to do its own operation as part of a larger picture. Data such as images enters this network as input, and flows through the network as it adapts itself at training time or predicts outputs in a deployed system.

Tensors are the standard way of representing data in deep learning. Simply put, tensors are just multidimensional arrays, an extension of two-dimensional tables (matrices) to data with higher dimensionality. Just as a black-and-white (grayscale) images are represented as “tables” of pixel values, RGB images are represented as tensors (three-dimensional arrays), with each pixel having three values corresponding to red, green, and blue components.

In TensorFlow, computation is approached as a *dataflow graph* (Figure 1-5). Broadly speaking, in this graph, nodes represent operations (such as addition or multiplication), and edges represent data (tensors) flowing around the system. In the next chapters, we will dive deeper into these concepts and learn to understand them with many examples.

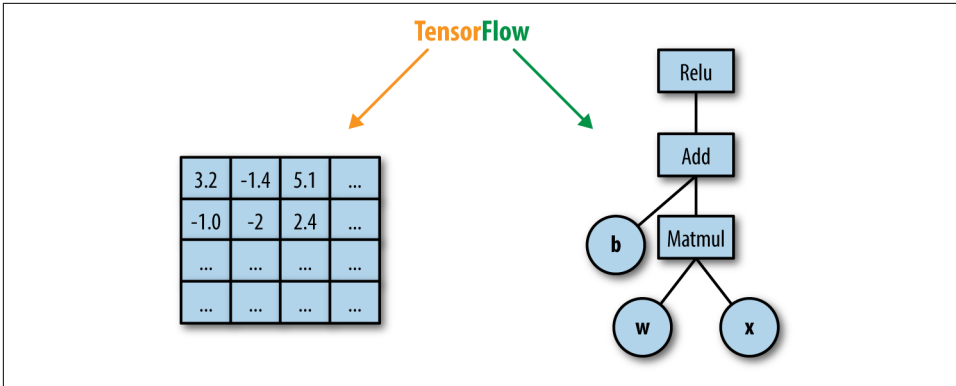

Figure 1-5. A dataflow computation graph. Data in the form of tensors flows through a graph of computational operations that make up our deep neural networks.

## A High-Level Overview

TensorFlow, in the most general terms, is a software framework for numerical computations based on dataflow graphs. It is designed primarily, however, as an interface for expressing and implementing machine learning algorithms, chief among them deep neural networks.

TensorFlow was designed with portability in mind, enabling these computation graphs to be executed across a wide variety of environments and hardware platforms. With essentially identical code, the same TensorFlow neural net could, for instance, be trained in the cloud, distributed over a cluster of many machines or on a single laptop. It can be deployed for serving predictions on a dedicated server or on mobile device platforms such as Android or iOS, or Raspberry Pi single-board computers. TensorFlow is also compatible, of course, with Linux, macOS, and Windows operating systems.

The core of TensorFlow is in C++, and it has two primary high-level frontend languages and interfaces for expressing and executing the computation graphs. The most developed frontend is in Python, used by most researchers and data scientists. The C++ frontend provides quite a low-level API, useful for efficient execution in embedded systems and other scenarios.

Aside from its portability, another key aspect of TensorFlow is its flexibility, allowing researchers and data scientists to express models with relative ease. It is sometimes revealing to think of modern deep learning research and practice as playing with “LEGO-like” bricks, replacing blocks of the network with others and seeing what happens, and at times designing new blocks. As we shall see throughout this book, TensorFlow provides helpful tools to use these modular blocks, combined with a flexible API that enables the writing of new ones. In deep learning, networks are trained with

a feedback process called backpropagation based on gradient descent optimization. TensorFlow flexibly supports many optimization algorithms, all with automatic differentiation—the user does not need to specify any gradients in advance, since TensorFlow derives them automatically based on the computation graph and loss function provided by the user. To monitor, debug, and visualize the training process, and to streamline experiments, TensorFlow comes with TensorBoard (Figure 1-6), a simple visualization tool that runs in the browser, which we will use throughout this book.

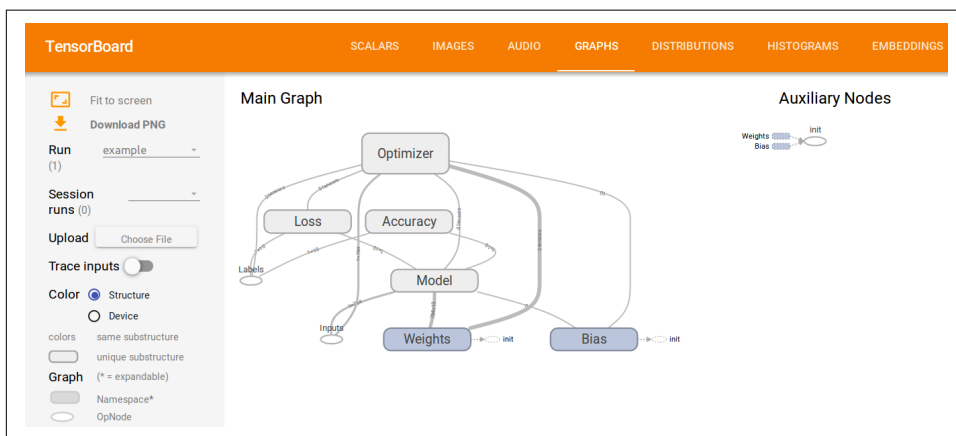

Figure 1-6. TensorFlow’s visualization tool, TensorBoard, for monitoring, debugging, and analyzing the training process and experiments.

Key enablers of TensorFlow’s flexibility for data scientists and researchers are high-level abstraction libraries. In state-of-the-art deep neural nets for computer vision or NLU, writing TensorFlow code can take a toll—it can become a complex, lengthy, and cumbersome endeavor. Abstraction libraries such as Keras and TF-Slim offer simplified high-level access to the “LEGO bricks” in the lower-level library, helping to streamline the construction of the dataflow graphs, training them, and running inference. Another key enabler for data scientists and engineers is the pretrained models that come with TF-Slim and TensorFlow. These models were trained on massive amounts of data with great computational resources, which are often hard to come by and in any case require much effort to acquire and set up. Using Keras or TF-Slim, for example, with just a few lines of code it is possible to use these advanced models for inference on incoming data, and also to fine-tune the models to adapt to new data.

The flexibility and portability of TensorFlow help make the flow from research to production smooth, cutting the time and effort it takes for data scientists to push their models to deployment in products and for engineers to translate algorithmic ideas into robust code.



## TensorFlow abstractions

TensorFlow comes with abstraction libraries such as Keras and TF-Slim, offering simplified high-level access to TensorFlow. These abstractions, which we will see later in this book, help streamline the construction of the dataflow graphs and enable us to train them and run inference with many fewer lines of code.

But beyond flexibility and portability, TensorFlow has a suite of properties and tools that make it attractive for engineers who build real-world AI systems. It has natural support for distributed training—indeed, it is used at Google and other large industry players to train massive networks on huge amounts of data, over clusters of many machines. In local implementations, training on multiple hardware devices requires few changes to code used for single devices. Code also remains relatively unchanged when going from local to distributed, which makes using TensorFlow in the cloud, on Amazon Web Services (AWS) or Google Cloud, particularly attractive. Additionally, as we will see further along in this book, TensorFlow comes with many more features aimed at boosting scalability. These include support for asynchronous computation with threading and queues, efficient I/O and data formats, and much more.

Deep learning continues to rapidly evolve, and so does TensorFlow, with frequent new and exciting additions, bringing better usability, performance, and value.

## Summary

With the set of tools and features described in this chapter, it becomes clear why TensorFlow has attracted so much attention in little more than a year. This book aims at first rapidly getting you acquainted with the basics and ready to work, and then we will dive deeper into the world of TensorFlow with exciting and practical examples.

---

# Go with the Flow: Up and Running with TensorFlow

In this chapter we start our journey with two working TensorFlow examples. The first (the traditional “hello world” program), while short and simple, includes many of the important elements we discuss in depth in later chapters. With the second, a first end-to-end machine learning model, you will embark on your journey toward state-of-the-art machine learning with TensorFlow.

Before getting started, we briefly walk through the installation of TensorFlow. In order to facilitate a quick and painless start, we install the CPU version only, and defer the GPU installation to later.<sup>1</sup> (If you don’t know what this means, that’s OK for the time being!) If you already have TensorFlow installed, skip to the second section.

## Installing TensorFlow

If you are using a clean Python installation (probably set up for the purpose of learning TensorFlow), you can get started with the simple `pip` installation:

```
$ pip install tensorflow
```

This approach does, however, have the drawback that TensorFlow will override existing packages and install specific versions to satisfy dependencies. If you are using this Python installation for other purposes as well, this will not do. One common way around this is to install TensorFlow in a virtual environment, managed by a utility called *virtualenv*.

---

<sup>1</sup> We refer the reader to the official [TensorFlow install guide](#) for further details, and especially the ever-changing details of GPU installations.

Depending on your setup, you may or may not need to install *virtualenv* on your machine. To install *virtualenv*, type:

```
$ pip install virtualenv
```

See <http://virtualenv.pypa.io> for further instructions.

In order to install TensorFlow in a virtual environment, you must first create the virtual environment—in this book we choose to place these in the `~/envs` folder, but feel free to put them anywhere you prefer:

```
$ cd ~
$ mkdir envs
$ virtualenv ~/envs/tensorflow
```

This will create a virtual environment named *tensorflow* in `~/envs` (which will manifest as the folder `~/envs/tensorflow`). To activate the environment, use:

```
$ source ~/envs/tensorflow/bin/activate
```

The prompt should now change to indicate the activated environment:

```
(tensorflow)$
```

At this point the `pip install` command:

```
(tensorflow)$ pip install tensorflow
```

will install TensorFlow into the virtual environment, without impacting other packages installed on your machine.

Finally, in order to exit the virtual environment, you type:

```
(tensorflow)$ deactivate
```

at which point you should get back the regular prompt:

```
$
```

## TensorFlow for Windows Users

Up until recently TensorFlow had been notoriously difficult to use with Windows machines. As of TensorFlow 0.12, however, Windows integration is here! It is as simple as:

```
pip install tensorflow
```

for the CPU version, or:

```
pip install tensorflow-gpu
```

for the GPU-enabled version (assuming you already have CUDA 8).





## Adding an alias to ~/.bashrc

The process described for entering and exiting your virtual environment might be too cumbersome if you intend to use it often. In this case, you can simply append the following command to your ~/.bashrc file:

```
alias tensorflow="source ~/envs/tensorflow/bin/activate"
```

and use the command `tensorflow` to activate the virtual environment. To quit the environment, you will still use `deactivate`.

Now that we have a basic installation of TensorFlow, we can proceed to our first working examples. We will follow the well-established tradition and start with a “hello world” program.

## Hello World

Our first example is a simple program that combines the words “Hello” and “World!” and displays the output—the phrase “Hello World!” While simple and straightforward, this example introduces many of the core elements of TensorFlow and the ways in which it is different from a regular Python program.

We suggest you run this example on your machine, play around with it a bit, and see what works. Next, we will go over the lines of code and discuss each element separately.

First, we run a simple install and version check (if you used the `virtualenv` installation option, make sure to activate it before running TensorFlow code):

```
import tensorflow as tf
print(tf.__version__)
```

If correct, the output will be the version of TensorFlow you have installed on your system. Version mismatches are the most probable cause of issues down the line.

**Example 2-1** shows the complete “hello world” example.

*Example 2-1. “Hello world” with TensorFlow*

```
import tensorflow as tf

h = tf.constant("Hello")
w = tf.constant(" World!")
hw = h + w

with tf.Session() as sess:
    ans = sess.run(hw)

print (ans)
```

We assume you are familiar with Python and imports, in which case the first line:

```
import tensorflow as tf
```

requires no explanation.



### IDE configuration

If you are running TensorFlow code from an IDE, then make sure to redirect to the virtualenv where the package is installed. Otherwise, you will get the following import error:

```
ImportError: No module named tensorflow
```

In the PyCharm IDE this is done by selecting Run→Edit Configurations, then changing Python Interpreter to point to `~/envs/tensorflow/bin/python`, assuming you used `~/envs/tensorflow` as the virtualenv directory.

Next, we define the constants "Hello" and " World!", and combine them:

```
import tensorflow as tf

h = tf.constant("Hello")
w = tf.constant(" World!")
hw = h + w
```

At this point, you might wonder how (if at all) this is different from the simple Python code for doing this:

```
ph = "Hello"
pw = " World!"
phw = h + w
```

The key point here is what the variable `hw` contains in each case. We can check this using the `print` command. In the pure Python case we get this:

```
>print phw
Hello World!
```

In the TensorFlow case, however, the output is completely different:

```
>print hw
Tensor("add:0", shape=(), dtype=string)
```

Probably not what you expected!

In the next chapter we explain the computation graph model of TensorFlow in detail, at which point this output will become completely clear. The key idea behind computation graphs in TensorFlow is that we first define what computations should take place, and then trigger the computation in an external mechanism. Thus, the TensorFlow line of code:

```
hw = h + w
```

does *not* compute the sum of `h` and `w`, but rather adds the summation operation to a graph of computations to be done later.

Next, the `Session` object acts as an interface to the external TensorFlow computation mechanism, and allows us to run parts of the computation graph we have already defined. The line:

```
ans = sess.run(hw)
```

actually computes `hw` (as the sum of `h` and `w`, the way it was defined previously), following which the printing of `ans` displays the expected “Hello World!” message.

This completes the first TensorFlow example. Next, we dive right in with a simple machine learning example, which already shows a great deal of the promise of the TensorFlow framework.

## MNIST

The *MNIST* (Mixed National Institute of Standards and Technology) handwritten digits dataset is one of the most researched datasets in image processing and machine learning, and has played an important role in the development of artificial neural networks (now generally referred to as *deep learning*).

As such, it is fitting that our first machine learning example should be dedicated to the classification of handwritten digits ([Figure 2-1](#) shows a random sample from the dataset). At this point, in the interest of keeping it simple, we will apply a very simple classifier. This simple model will suffice to classify approximately 92% of the test set correctly—the best models currently available reach over 99.75% correct classification, but we have a few more chapters to go until we get there! Later in the book, we will revisit this data and use more sophisticated methods.



Figure 2-1. 100 random MNIST images

## Softmax Regression

In this example we will use a simple classifier called *softmax regression*. We will not go into the mathematical formulation of the model in too much detail (there are plenty of good resources where you can find this information, and we strongly suggest that you do so, if you have never seen this before). Rather, we will try to provide some intuition into the way the model is able to solve the digit recognition problem.

Put simply, the softmax regression model will figure out, for each pixel in the image, which digits tend to have high (or low) values in that location. For instance, the center of the image will tend to be white for zeros, but black for sixes. Thus, a black pixel

in the center of an image will be evidence against the image containing a zero, and in favor of it containing a six.

Learning in this model consists of finding weights that tell us how to accumulate evidence for the existence of each of the digits. With softmax regression, we will not use the spatial information in the pixel layout in the image. Later on, when we discuss convolutional neural networks, we will see that utilizing spatial information is one of the key elements in making great image-processing and object-recognition models.

Since we are not going to use the spatial information at this point, we will unroll our image pixels as a single long vector denoted  $x$  (Figure 2-2). Then

$$xw^0 = \sum x_i w_i^0$$

will be the evidence for the image containing the digit 0 (and in the same way we will have  $w^d$  weight vectors for each one of the other digits,  $d = 1, \dots, 9$ ).

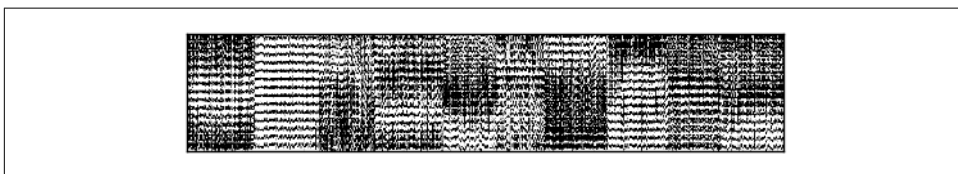

Figure 2-2. MNIST image pixels unrolled to vectors and stacked as columns (sorted by digit from left to right). While the loss of spatial information doesn't allow us to recognize the digits, the block structure evident in this figure is what allows the softmax model to classify images. Essentially, all zeros (leftmost block) share a similar pixel structure, as do all ones (second block from the left), etc.

All this means is that we sum up the pixel values, each multiplied by a weight, which we think of as the importance of this pixel in the overall evidence for the digit zero being in the image.<sup>2</sup>

For instance,  $w_{38}^0$  will be a large positive number if the 38th pixel having a high intensity points strongly to the digit being a zero, a strong negative number if high-intensity values in this position occur mostly in other digits, and zero if the intensity value of the 38th pixel tells us nothing about whether or not this digit is a zero.<sup>3</sup>

Performing this calculation at once for all digits (computing the evidence for each of the digits appearing in the image) can be represented by a single matrix operation. If

---

2 It is common to add a “bias term,” which is equivalent to stating which digits we believe an image to be before seeing the pixel values. If you have seen this before, then try adding it to the model and check how it affects the results.

3 If you are familiar with softmax regression, you probably realize this is a simplification of the way it works, especially when pixel values are as correlated as with digit images.

we place the weights for each of the digits in the columns of a matrix  $W$ , then the length-10 vector with the evidence for each of the digits is

$$[xw^0 \dots xw^9] = xW$$

The purpose of learning a classifier is almost always to evaluate new examples. In this case, this means that we would like to be able to tell what digit is written in a new image we have not seen in our training data. In order to do this, we start by summing up the evidence for each of the 10 possible digits (i.e., computing  $xW$ ). The final assignment will be the digit that “wins” by accumulating the most evidence:

$$\text{digit} = \text{argmax}(xW)$$

We start by presenting the code for this example in its entirety (Example 2-2), then walk through it line by line and go over the details. You may find that there are many novel elements or that some pieces of the puzzle are missing at this stage, but our advice is that you go with it for now. Everything will become clear in due course.

*Example 2-2. Classifying MNIST handwritten digits with softmax regression*

```
import tensorflow as tf
from tensorflow.examples.tutorials.mnist import input_data

DATA_DIR = '/tmp/data'
NUM_STEPS = 1000
MINIBATCH_SIZE = 100

data = input_data.read_data_sets(DATA_DIR, one_hot=True)

x = tf.placeholder(tf.float32, [None, 784])
W = tf.Variable(tf.zeros([784, 10]))

y_true = tf.placeholder(tf.float32, [None, 10])
y_pred = tf.matmul(x, W)

cross_entropy = tf.reduce_mean(tf.nn.softmax_cross_entropy_with_logits(
    logits=y_pred, labels=y_true))

gd_step = tf.train.GradientDescentOptimizer(0.5).minimize(cross_entropy)

correct_mask = tf.equal(tf.argmax(y_pred, 1), tf.argmax(y_true, 1))
accuracy = tf.reduce_mean(tf.cast(correct_mask, tf.float32))

with tf.Session() as sess:

    # Train
    sess.run(tf.global_variables_initializer())
```



```

for _ in range(NUM_STEPS):
    batch_xs, batch_ys = data.train.next_batch(MINIBATCH_SIZE)
    sess.run(gd_step, feed_dict={x: batch_xs, y_true: batch_ys})

# Test
ans = sess.run(accuracy, feed_dict={x: data.test.images,
                                   y_true: data.test.labels})

print "Accuracy: {:.4}%".format(ans*100)

```

If you run the code on your machine, you should get output like this:

```

Extracting /tmp/data/train-images-idx3-ubyte.gz
Extracting /tmp/data/train-labels-idx1-ubyte.gz
Extracting /tmp/data/t10k-images-idx3-ubyte.gz
Extracting /tmp/data/t10k-labels-idx1-ubyte.gz
Accuracy: 91.83%

```

That's all it takes! If you have put similar models together before using other platforms, you might appreciate the simplicity and readability. However, these are just side bonuses, with the efficiency and flexibility gained from the computation graph model of TensorFlow being what we are really interested in.

The exact accuracy value you get will be just under 92%. If you run the program once more, you will get another value. This sort of stochasticity is very common in machine learning code, and you have probably seen similar results before. In this case, the source is the changing order in which the handwritten digits are presented to the model during learning. As a result, the learned parameters following training are slightly different from run to run.

Running the same program five times might therefore produce this result:

```

Accuracy: 91.86%
Accuracy: 91.51%
Accuracy: 91.62%
Accuracy: 91.93%
Accuracy: 91.88%

```

We will now briefly go over the code for this example and see what is new from the previous “hello world” example. We’ll break it down line by line:

```

import tensorflow as tf
from tensorflow.examples.tutorials.mnist import input_data

```

The first new element in this example is that we use external data! Rather than downloading the MNIST dataset (freely available at <http://yann.lecun.com/exdb/mnist/>) and loading it into our program, we use a built-in utility for retrieving the dataset on the fly. Such utilities exist for most popular datasets, and when dealing with small ones (in this case only a few MB), it makes a lot of sense to do it this way. The second

import loads the utility we will later use both to automatically download the data for us, and to manage and partition it as needed:

```
DATA_DIR = '/tmp/data'  
NUM_STEPS = 1000  
MINIBATCH_SIZE = 100
```

Here we define some constants that we use in our program—these will each be explained in the context in which they are first used:

```
data = input_data.read_data_sets(DATA_DIR, one_hot=True)
```

The `read_data_sets()` method of the MNIST reading utility downloads the dataset and saves it locally, setting the stage for further use later in the program. The first argument, `DATA_DIR`, is the location we wish the data to be saved to locally. We set this to `'/tmp/data'`, but any other location would be just as good. The second argument tells the utility how we want the data to be labeled; we will not go into this right now.<sup>4</sup>

Note that this is what prints the first four lines of the output, indicating the data was obtained correctly. Now we are finally ready to set up our model:

```
x = tf.placeholder(tf.float32, [None, 784])  
W = tf.Variable(tf.zeros([784, 10]))
```

In the previous example we saw the TensorFlow constant element—this is now complemented by the `placeholder` and `Variable` elements. For now, it is enough to know that a variable is an element manipulated by the computation, while a placeholder has to be supplied when triggering it. The image itself (`x`) is a placeholder, because it will be supplied by us when running the computation graph. The size `[None, 784]` means that each image is of size 784 (28×28 pixels unrolled into a single vector), and `None` is an indicator that we are not currently specifying how many of these images we will use at once:

```
y_true = tf.placeholder(tf.float32, [None, 10])  
y_pred = tf.matmul(x, W)
```

In the next chapter these concepts will be dealt with in much more depth.

A key concept in a large class of machine learning tasks is that we would like to learn a function from data examples (in our case, digit images) to their known labels (the identity of the digit in the image). This setting is called *supervised learning*. In most supervised learning models, we attempt to learn a model such that the true labels and the predicted labels are close in some sense. Here, `y_true` and `y_pred` are the elements representing the true and predicted labels, respectively:

---

<sup>4</sup> Here and throughout, before running the example code, make sure `DATA_DIR` fits the operating system you are using. On Windows, for instance, you would probably use something like `c:\tmp\data` instead.

```
cross_entropy = tf.reduce_mean(tf.nn.softmax_cross_entropy_with_logits(
    logits=y_pred, labels=y_true))
```

The measure of similarity we choose for this model is what is known as *cross entropy*—a natural choice when the model outputs class probabilities. This element is often referred to as the *loss function*:<sup>5</sup>

```
gd_step = tf.train.GradientDescentOptimizer(0.5).minimize(cross_entropy)
```

The final piece of the model is how we are going to train it (i.e., how we are going to minimize the loss function). A very common approach is to use gradient descent optimization. Here, 0.5 is the learning rate, controlling how fast our gradient descent optimizer shifts model weights to reduce overall loss.

We will discuss optimizers and how they fit into the computation graph later on in the book.

Once we have defined our model, we want to define the evaluation procedure we will use in order to test the accuracy of the model. In this case, we are interested in the fraction of test examples that are correctly classified:<sup>6</sup>

```
correct_mask = tf.equal(tf.argmax(y_pred, 1), tf.argmax(y_true, 1))
accuracy = tf.reduce_mean(tf.cast(correct_mask, tf.float32))
```

As with the “hello world” example, in order to make use of the computation graph we defined, we must create a session. The rest happens within the session:

```
with tf.Session() as sess:
```

First, we must initialize all variables:

```
sess.run(tf.global_variables_initializer())
```

This carries some specific implications in the realm of machine learning and optimization, which we will discuss further when we use models for which initialization is an important issue

## Supervised Learning and the Train/Test Scheme

Supervised learning generally refers to the task of learning a function from data objects to labels associated with them, based on a set of examples where the correct labels are already known. This is usually subdivided into the case where labels are continuous (regression) or discrete (classification).

The purpose of training supervised learning models is almost always to apply them later to new examples with unknown labels, in order to obtain predicted labels for

---

5 As of TensorFlow 1.0 this is also contained in `tf.losses.softmax_cross_entropy`.

6 As of TensorFlow 1.0 this is also contained in `tf.metrics.accuracy`.

them. In the MNIST case discussed in this section, the purpose of training the model would probably be to apply it on new handwritten digit images and automatically find out what digits they represent.

As a result, we are interested in the extent to which our model will label new examples correctly. This is reflected in the way we evaluate the accuracy of the model. We first partition the labeled dataset into train and test partitions. During model training we use only the train partition, and during evaluation we test the accuracy only on the test partition. This scheme is generally known as a *train/test validation*.

```
for _ in range(NUM_STEPS):
    batch_xs, batch_ys = data.train.next_batch(MINIBATCH_SIZE)
    sess.run(gd_step, feed_dict={x: batch_xs, y_true: batch_ys})
```

The actual training of the model, in the gradient descent approach, consists of taking many steps in “the right direction.” The number of steps we will make, `NUM_STEPS`, was set to 1,000 in this case. There are more sophisticated ways of deciding when to stop, but more about that later! In each step we ask our data manager for a bunch of examples with their labels and present them to the learner. The `MINIBATCH_SIZE` constant controls the number of examples to use for each step.

Finally, we use the `feed_dict` argument of `sess.run` for the first time. Recall that we defined placeholder elements when constructing the model. Now, each time we want to run a computation that will include these elements, we must supply a value for them.

```
ans = sess.run(accuracy, feed_dict={x: data.test.images,
                                   y_true: data.test.labels})
```

In order to evaluate the model we have just finished learning, we run the accuracy computing operation defined earlier (recall the accuracy was defined as the fraction of images that are correctly labeled). In this procedure, we feed a separate group of test images, which were never seen by the model during training:

```
print "Accuracy: {:.4}%".format(ans*100)
```

Lastly, we print out the results as percent values.

Figure 2-3 shows a graph representation of our model.

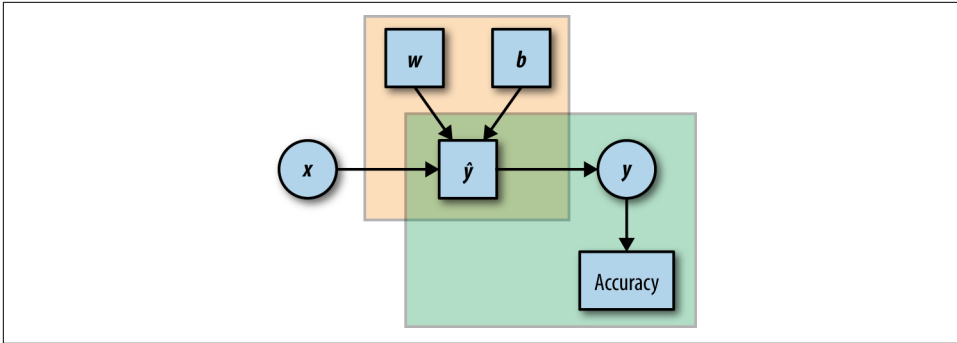

Figure 2-3. A graph representation of the model. Rectangular elements are Variables, and circles are placeholders. The top-left frame represents the label prediction part, and the bottom-right frame the evaluation.



### Model evaluation and memory errors

When using TensorFlow, like any other system, it is important to be aware of the resources being used, and make sure not to exceed the capacity of the system. One possible pitfall is in the evaluation of models—testing their performance on a test set. In this example we evaluate the accuracy of the models by feeding all the test examples in one go:

```
feed_dict={x: data.test.images, y_true: data.test.labels}
ans = sess.run(accuracy, feed_dict)
```

If all the test examples (here, `data.test.images`) are not able to fit into the memory in the system you are using, you will get a memory error at this point. This is likely to be the case, for instance, if you are running this example on a typical low-end GPU.

The easy way around this (getting a machine with more memory is a temporary fix, since there will always be larger datasets) is to split the test procedure into batches, much as we did during training.

## Summary

Congratulations! By now you have installed TensorFlow and taken it for a spin with two basic examples. You have seen some of the fundamental building blocks that will be used throughout the book, and have hopefully begun to get a feel for TensorFlow.

Next, we take a look under the hood and explore the computation graph model used by TensorFlow.



---

# Understanding TensorFlow Basics

This chapter demonstrates the key concepts of how TensorFlow is built and how it works with simple and intuitive examples. You will get acquainted with the basics of TensorFlow as a numerical computation library using dataflow graphs. More specifically, you will learn how to manage and create a graph, and be introduced to TensorFlow’s “building blocks,” such as constants, placeholders, and Variables.

## Computation Graphs

TensorFlow allows us to implement machine learning algorithms by creating and computing operations that interact with one another. These interactions form what we call a “computation graph,” with which we can intuitively represent complicated functional architectures.

### What Is a Computation Graph?

We assume a lot of readers have already come across the mathematical concept of a graph. For those to whom this concept is new, a graph refers to a set of interconnected *entities*, commonly called *nodes* or *vertices*. These nodes are connected to each other via edges. In a dataflow graph, the edges allow data to “flow” from one node to another in a directed manner.

In TensorFlow, each of the graph’s nodes represents an operation, possibly applied to some input, and can generate an output that is passed on to other nodes. By analogy, we can think of the graph computation as an assembly line where each machine (node) either gets or creates its raw material (input), processes it, and then passes the output to other machines in an orderly fashion, producing *subcomponents* and eventually a final *product* when the assembly process comes to an end.

Operations in the graph include all kinds of functions, from simple arithmetic ones such as subtraction and multiplication to more complex ones, as we will see later on. They also include more general operations like the creation of summaries, generating constant values, and more.

## The Benefits of Graph Computations

TensorFlow optimizes its computations based on the graph's connectivity. Each graph has its own set of node dependencies. When the input of node *y* is affected by the output of node *x*, we say that node *y* is dependent on node *x*. We call it a *direct dependency* when the two are connected via an edge, and an *indirect dependency* otherwise. For example, in [Figure 3-1](#) (A), node *e* is directly dependent on node *c*, indirectly dependent on node *a*, and independent of node *d*.

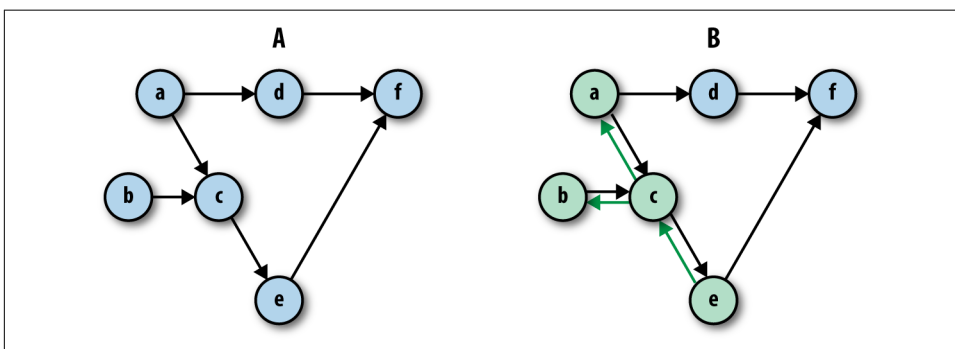

Figure 3-1. (A) Illustration of graph dependencies. (B) Computing node *e* results in the minimal amount of computations according to the graph's dependencies—in this case computing only nodes *c*, *b*, and *a*.

We can always identify the full set of dependencies for each node in the graph. This is a fundamental characteristic of the graph-based computation format. Being able to locate dependencies between units of our model allows us to both distribute computations across available resources and avoid performing redundant computations of irrelevant subsets, resulting in a faster and more efficient way of computing things.

## Graphs, Sessions, and Fetches

Roughly speaking, working with TensorFlow involves two main phases: (1) constructing a graph and (2) executing it. Let's jump into our first example and create something very basic.



## Creating a Graph

Right after we import TensorFlow (with `import tensorflow as tf`), a specific empty default graph is formed. All the nodes we create are automatically associated with that default graph.

Using the `tf.<operator>` methods, we will create six nodes assigned to arbitrarily named variables. The contents of these variables should be regarded as the output of the operations, and not the operations themselves. For now we refer to both the operations and their outputs with the names of their corresponding variables.

The first three nodes are each told to output a constant value. The values 5, 2, and 3 are assigned to `a`, `b`, and `c`, respectively:

```
a = tf.constant(5)
b = tf.constant(2)
c = tf.constant(3)
```

Each of the next three nodes gets two existing variables as inputs, and performs simple arithmetic operations on them:

```
d = tf.multiply(a,b)
e = tf.add(c,b)
f = tf.subtract(d,e)
```

Node `d` multiplies the outputs of nodes `a` and `b`. Node `e` adds the outputs of nodes `b` and `c`. Node `f` subtracts the output of node `e` from that of node `d`.

And *voilà!* We have our first TensorFlow graph! [Figure 3-2](#) shows an illustration of the graph we've just created.

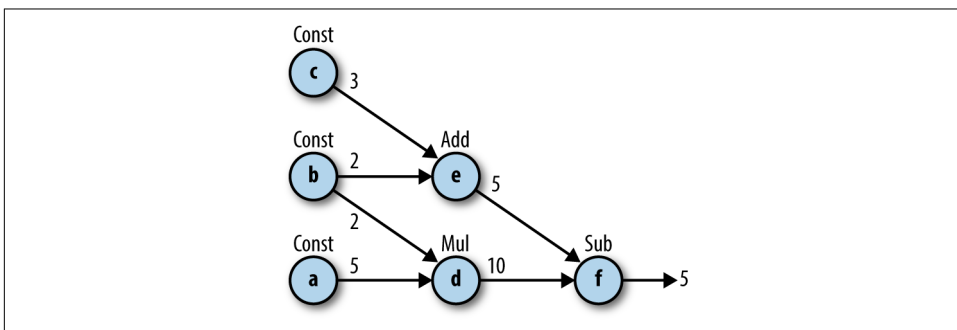

*Figure 3-2. An illustration of our first constructed graph. Each node, denoted by a lowercase letter, performs the operation indicated above it: `Const` for creating constants and `Add`, `Mul`, and `Sub` for addition, multiplication, and subtraction, respectively. The integer next to each edge is the output of the corresponding node's operation.*

Note that for some arithmetic and logical operations it is possible to use operation shortcuts instead of having to apply `tf.<operator>`. For example, in this graph we

could have used `*/+/-` instead of `tf.multiply()/tf.add()/tf.subtract()` (like we did in the “hello world” example in [Chapter 2](#), where we used `+` instead of `tf.add()`). [Table 3-1](#) lists the available shortcuts.

*Table 3-1. Common TensorFlow operations and their respective shortcuts*

TensorFlow operator	Shortcut	Description
<code>tf.add()</code>	<code>a + b</code>	Adds <code>a</code> and <code>b</code> , element-wise.
<code>tf.multiply()</code>	<code>a * b</code>	Multiplies <code>a</code> and <code>b</code> , element-wise.
<code>tf.subtract()</code>	<code>a - b</code>	Subtracts <code>a</code> from <code>b</code> , element-wise.
<code>tf.divide()</code>	<code>a / b</code>	Computes Python-style division of <code>a</code> by <code>b</code> .
<code>tf.pow()</code>	<code>a ** b</code>	Returns the result of raising each element in <code>a</code> to its corresponding element <code>b</code> , element-wise.
<code>tf.mod()</code>	<code>a % b</code>	Returns the element-wise modulo.
<code>tf.logical_and()</code>	<code>a &amp; b</code>	Returns the truth table of <code>a &amp; b</code> , element-wise. <code>dtype</code> must be <code>tf.bool</code> .
<code>tf.greater()</code>	<code>a &gt; b</code>	Returns the truth table of <code>a &gt; b</code> , element-wise.
<code>tf.greater_equal()</code>	<code>a &gt;= b</code>	Returns the truth table of <code>a &gt;= b</code> , element-wise.
<code>tf.less_equal()</code>	<code>a &lt;= b</code>	Returns the truth table of <code>a &lt;= b</code> , element-wise.
<code>tf.less()</code>	<code>a &lt; b</code>	Returns the truth table of <code>a &lt; b</code> , element-wise.
<code>tf.negative()</code>	<code>-a</code>	Returns the negative value of each element in <code>a</code> .
<code>tf.logical_not()</code>	<code>~a</code>	Returns the logical NOT of each element in <code>a</code> . Only compatible with Tensor objects with <code>dtype</code> of <code>tf.bool</code> .
<code>tf.abs()</code>	<code>abs(a)</code>	Returns the absolute value of each element in <code>a</code> .
<code>tf.logical_or()</code>	<code>a   b</code>	Returns the truth table of <code>a   b</code> , element-wise. <code>dtype</code> must be <code>tf.bool</code> .

## Creating a Session and Running It

Once we are done describing the computation graph, we are ready to run the computations that it represents. For this to happen, we need to create and run a session. We do this by adding the following code:

```
sess = tf.Session()
outs = sess.run(f)
sess.close()
print("outs = {}".format(outs))
```

```
Out:
outs = 5
```

First, we launch the graph in a `tf.Session`. A `Session` object is the part of the TensorFlow API that communicates between Python objects and data on our end, and the actual computational system where memory is allocated for the objects we define, intermediate variables are stored, and finally results are fetched for us.

```
sess = tf.Session()
```

The execution itself is then done with the `.run()` method of the `Session` object. When called, this method completes one set of computations in our graph in the following manner: it starts at the requested output(s) and then works backward, computing nodes that must be executed according to the set of dependencies. Therefore, the part of the graph that will be computed depends on our output query.

In our example, we requested that node `f` be computed and got its value, 5, as output:

```
outs = sess.run(f)
```

When our computation task is completed, it is good practice to close the session using the `sess.close()` command, making sure the resources used by our session are freed up. This is an important practice to maintain even though we are not obligated to do so for things to work:

```
sess.close()
```

*Example 3-1. Try it yourself! Figure 3-3 shows another two graph examples. See if you can produce these graphs yourself.*

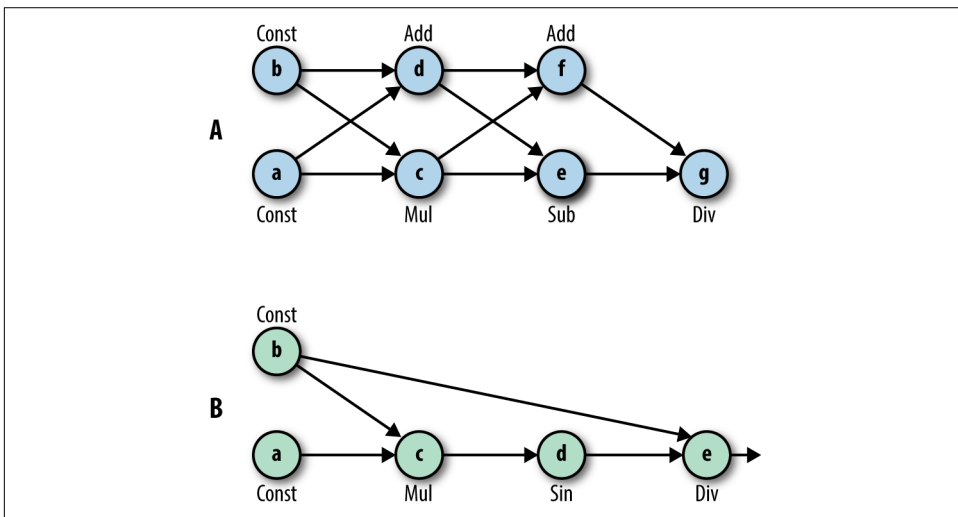

Figure 3-3. Can you create graphs A and B? (To produce the sine function, use `tf.sin(x)`).

## Constructing and Managing Our Graph

As mentioned, as soon as we import TensorFlow, a default graph is automatically created for us. We can create additional graphs and control their association with some given operations. `tf.Graph()` creates a new graph, represented as a TensorFlow object. In this example we create another graph and assign it to the variable `g`:

```
import tensorflow as tf
print(tf.get_default_graph())
```

```
g = tf.Graph()
print(g)
```

Out:

```
<tensorflow.python.framework.ops.Graph object at 0x7fd88c3c07d0>
<tensorflow.python.framework.ops.Graph object at 0x7fd88c3c03d0>
```

At this point we have two graphs: the default graph and the empty graph in `g`. Both are revealed as TensorFlow objects when printed. Since `g` hasn't been assigned as the default graph, any operation we create will not be associated with it, but rather with the default one.

We can check which graph is currently set as the default by using `tf.get_default_graph()`. Also, for a given node, we can view the graph it's associated with by using the `<node>.graph` attribute:

```
g = tf.Graph()
a = tf.constant(5)

print(a.graph is g)
print(a.graph is tf.get_default_graph())
```

Out:

```
False
True
```

In this code example we see that the operation we've created is associated with the default graph and not with the graph in `g`.

To make sure our constructed nodes are associated with the right graph we can construct them using a very useful Python construct: the `with` statement.



### The with statement

The `with` statement is used to wrap the execution of a block with methods defined by a context manager—an object that has the special method functions `__enter__()` to set up a block of code and `__exit__()` to exit the block.

In layman's terms, it's very convenient in many cases to execute some code that requires “setting up” of some kind (like opening a file, SQL table, etc.) and then always “tearing it down” at the end, regardless of whether the code ran well or raised any kind of exception. In our case we use `with` to set up a graph and make sure every piece of code will be performed in the context of that graph.

We use the `with` statement together with the `as_default()` command, which returns a context manager that makes this graph the default one. This comes in handy when working with multiple graphs:

```
g1 = tf.get_default_graph()
g2 = tf.Graph()

print(g1 is tf.get_default_graph())

with g2.as_default():
    print(g1 is tf.get_default_graph())

print(g1 is tf.get_default_graph())
```

```
Out:
True
False
True
```

The `with` statement can also be used to start a session without having to explicitly close it. This convenient trick will be used in the following examples.

## Fetches

In our initial graph example, we request one specific node (node `f`) by passing the variable it was assigned to as an argument to the `sess.run()` method. This argument is called `fetches`, corresponding to the elements of the graph we wish to compute. We can also ask `sess.run()` for multiple nodes' outputs simply by inputting a list of requested nodes:

```
with tf.Session() as sess:
    fetches = [a,b,c,d,e,f]
    outs = sess.run(fetches)

print("outs = {}".format(outs))
print(type(outs[0]))
```

```
Out:
outs = [5, 2, 3, 10, 5, 5]
<type 'numpy.int32'>
```

We get back a list containing the outputs of the nodes according to how they were ordered in the input list. The data in each item of the list is of type NumPy.



## NumPy

NumPy is a popular and useful Python package for numerical computing that offers many functionalities related to working with arrays. We assume some basic familiarity with this package, and it will not be covered in this book. TensorFlow and NumPy are tightly coupled—for example, the output returned by `sess.run()` is a NumPy array. In addition, many of TensorFlow's operations share the same syntax as functions in NumPy. To learn more about NumPy, we refer the reader to Eli Bressert's book *SciPy and NumPy* (O'Reilly).

We mentioned that TensorFlow computes only the essential nodes according to the set of dependencies. This is also manifested in our example: when we ask for the output of node `d`, only the outputs of nodes `a` and `b` are computed. Another example is shown in [Figure 3-1\(B\)](#). This is a great advantage of TensorFlow—it doesn't matter how big and complicated our graph is as a whole, since we can run just a small portion of it as needed.



## Automatically closing the session

Opening a session using the `with` clause will ensure the session is automatically closed once all computations are done.

# Flowing Tensors

In this section we will get a better understanding of how nodes and edges are actually represented in TensorFlow, and how we can control their characteristics. To demonstrate how they work, we will focus on source operations, which are used to initialize values.

## Nodes Are Operations, Edges Are Tensor Objects

When we construct a node in the graph, like we did with `tf.add()`, we are actually creating an operation instance. These operations do not produce actual values until the graph is executed, but rather reference their to-be-computed result as a handle that can be passed on—*flow*—to another node. These handles, which we can think of as the edges in our graph, are referred to as Tensor objects, and this is where the name TensorFlow originates from.

TensorFlow is designed such that first a skeleton graph is created with all of its components. At this point no actual data flows in it and no computations take place. It is only upon execution, when we run the session, that data enters the graph and compu-

tations occur (as illustrated in Figure 3-4). This way, computations can be much more efficient, taking the entire graph structure into consideration.

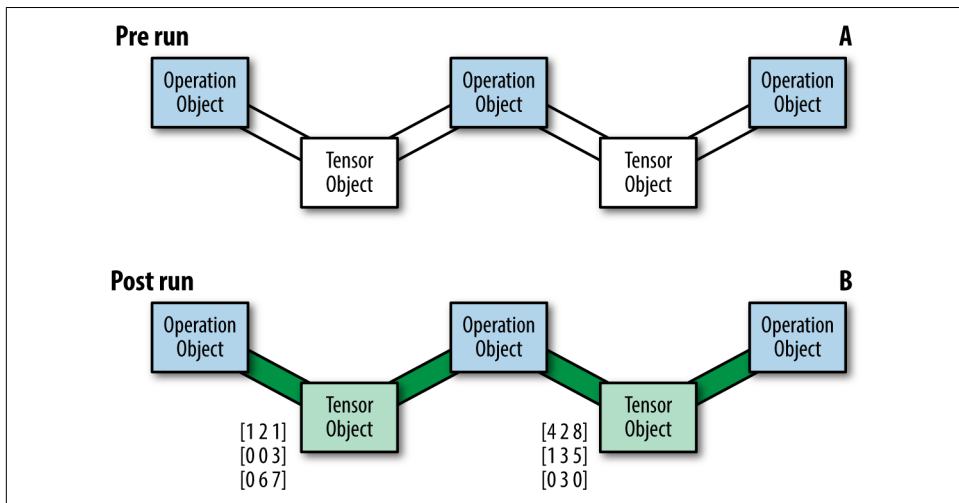

Figure 3-4. Illustrations of before (A) and after (B) running a session. When the session is run, actual data “flows” through the graph.

In the previous section’s example, `tf.constant()` created a node with the corresponding passed value. Printing the output of the constructor, we see that it’s actually a Tensor object instance. These objects have methods and attributes that control their behavior and that can be defined upon creation.

In this example, the variable `c` stores a Tensor object with the name `Const_52:0`, designated to contain a 32-bit floating-point scalar:

```
c = tf.constant(4.0)
print(c)

Out:
Tensor("Const_52:0", shape=(), dtype=float32)
```



### A note on constructors

The `tf.<operator>` function could be thought of as a constructor, but to be more precise, this is actually not a constructor at all, but rather a factory method that sometimes does quite a bit more than just creating the operator objects.

### Setting attributes with source operations

Each Tensor object in TensorFlow has attributes such as `name`, `shape`, and `dtype` that help identify and set the characteristics of that object. These attributes are optional

when creating a node, and are set automatically by TensorFlow when missing. In the next section we will take a look at these attributes. We will do so by looking at Tensor objects created by ops known as *source operations*. Source operations are operations that create data, usually without using any previously processed inputs. With these operations we can create scalars, as we already encountered with the `tf.constant()` method, as well as arrays and other types of data.

## Data Types

The basic units of data that pass through a graph are numerical, Boolean, or string elements. When we print out the Tensor object `c` from our last code example, we see that its data type is a floating-point number. Since we didn't specify the type of data, TensorFlow inferred it automatically. For example 5 is regarded as an integer, while anything with a decimal point, like 5.1, is regarded as a floating-point number.

We can explicitly choose what data type we want to work with by specifying it when we create the Tensor object. We can see what type of data was set for a given Tensor object by using the attribute `dtype`:

```
c = tf.constant(4.0, dtype=tf.float64)
print(c)
print(c.dtype)

Out:
Tensor("Const_10:0", shape=(), dtype=float64)
<dtype: 'float64'>
```

Explicitly asking for (appropriately sized) integers is on the one hand more memory conserving, but on the other may result in reduced accuracy as a consequence of not tracking digits after the decimal point.

## Casting

It is important to make sure our data types match throughout the graph—performing an operation with two nonmatching data types will result in an exception. To change the data type setting of a Tensor object, we can use the `tf.cast()` operation, passing the relevant Tensor and the new data type of interest as the first and second arguments, respectively:

```
x = tf.constant([1,2,3],name='x',dtype=tf.float32)
print(x.dtype)
x = tf.cast(x,tf.int64)
print(x.dtype)

Out:
<dtype: 'float32'>
<dtype: 'int64'>
```



TensorFlow supports many data types. These are listed in [Table 3-2](#).

Table 3-2. Supported Tensor data types

Data type	Python type	Description
DT_FLOAT	<code>tf.float32</code>	32-bit floating point.
DT_DOUBLE	<code>tf.float64</code>	64-bit floating point.
DT_INT8	<code>tf.int8</code>	8-bit signed integer.
DT_INT16	<code>tf.int16</code>	16-bit signed integer.
DT_INT32	<code>tf.int32</code>	32-bit signed integer.
DT_INT64	<code>tf.int64</code>	64-bit signed integer.
DT_UINT8	<code>tf.uint8</code>	8-bit unsigned integer.
DT_UINT16	<code>tf.uint16</code>	16-bit unsigned integer.
DT_STRING	<code>tf.string</code>	Variable-length byte array. Each element of a Tensor is a byte array.
DT_BOOL	<code>tf.bool</code>	Boolean.
DT_COMPLEX64	<code>tf.complex64</code>	Complex number made of two 32-bit floating points: real and imaginary parts.
DT_COMPLEX128	<code>tf.complex128</code>	Complex number made of two 64-bit floating points: real and imaginary parts.
DT_QINT8	<code>tf.qint8</code>	8-bit signed integer used in quantized ops.
DT_QINT32	<code>tf.qint32</code>	32-bit signed integer used in quantized ops.
DT_QUINT8	<code>tf.quint8</code>	8-bit unsigned integer used in quantized ops.

## Tensor Arrays and Shapes

A source of potential confusion is that two different things are referred to by the name, *Tensor*. As used in the previous sections, *Tensor* is the name of an object used in the Python API as a handle for the result of an operation in the graph. However, *tensor* is also a mathematical term for  $n$ -dimensional arrays. For example, a  $1 \times 1$  tensor is a scalar, a  $1 \times n$  tensor is a vector, an  $n \times n$  tensor is a matrix, and an  $n \times n \times n$  tensor is just a three-dimensional array. This, of course, generalizes to any dimension. TensorFlow regards all the data units that flow in the graph as tensors, whether they are multidimensional arrays, vectors, matrices, or scalars. The TensorFlow objects called Tensors are named after these mathematical tensors.

To clarify the distinction between the two, from now on we will refer to the former as Tensors with a capital T and the latter as tensors with a lowercase t.

As with `dtype`, unless stated explicitly, TensorFlow automatically infers the shape of the data. When we printed out the Tensor object at the beginning of this section, it showed that its shape was `()`, corresponding to the shape of a scalar.

Using scalars is good for demonstration purposes, but most of the time it's much more practical to work with multidimensional arrays. To initialize high-dimensional arrays, we can use Python lists or NumPy arrays as inputs. In the following example,

we use as inputs a 2×3 matrix using a Python list and then a 3D NumPy array of size 2×2×3 (two matrices of size 2×3):

```
import numpy as np

c = tf.constant([[1,2,3],
                [4,5,6]])
print("Python List input: {}".format(c.get_shape()))

c = tf.constant(np.array([
    [[1,2,3],
     [4,5,6]],

    [[1,1,1],
     [2,2,2]]
]))

print("3d NumPy array input: {}".format(c.get_shape()))

Out:
Python list input: (2, 3)
3d NumPy array input: (2, 2, 3)
```

The `get_shape()` method returns the shape of the tensor as a tuple of integers. The number of integers corresponds to the number of dimensions of the tensor, and each integer is the number of array entries along that dimension. For example, a shape of (2,3) indicates a matrix, since it has two integers, and the size of the matrix is 2×3.

Other types of source operation constructors are very useful for initializing constants in TensorFlow, like filling a constant value, generating random numbers, and creating sequences.

Random-number generators have special importance as they are used in many cases to create the initial values for TensorFlow Variables, which will be introduced shortly. For example, we can generate random numbers from a *normal distribution* using `tf.random.normal()`, passing the shape, mean, and standard deviation as the first, second, and third arguments, respectively. Another two examples for useful random initializers are the *truncated normal* that, as its name implies, cuts off all values below and above two standard deviations from the mean, and the *uniform* initializer that samples values uniformly within some interval [a,b).

Examples of sampled values for each of these methods are shown in [Figure 3-5](#).

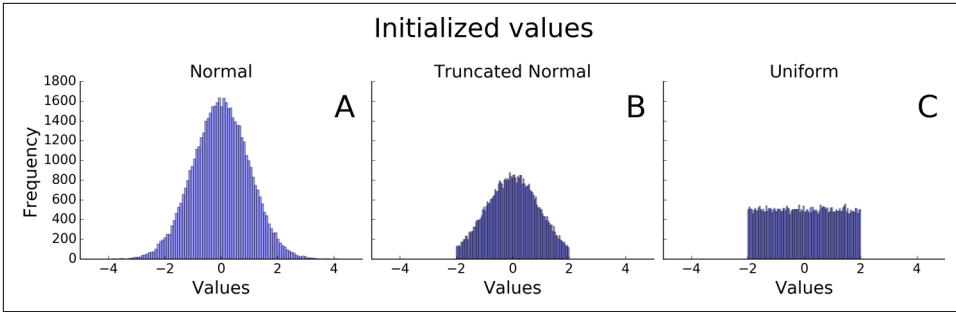

Figure 3-5. 50,000 random samples generated from (A) standard normal distribution, (B) truncated normal, and (C) uniform  $[-2,2)$ .

Those who are familiar with NumPy will recognize some of the initializers, as they share the same syntax. One example is the sequence generator `tf.linspace(a, b, n)` that creates  $n$  evenly spaced values from  $a$  to  $b$ .

A feature that is convenient to use when we want to explore the data content of an object is `tf.InteractiveSession()`. Using it and the `.eval()` method, we can get a full look at the values without the need to constantly refer to the session object:

```
sess = tf.InteractiveSession()
c = tf.linspace(0.0, 4.0, 5)
print("The content of 'c':\n {}".format(c.eval()))
sess.close()
```

```
Out:
The content of 'c':
[ 0.  1.  2.  3.  4.]
```



### Interactive sessions

`tf.InteractiveSession()` allows you to replace the usual `tf.Session()`, so that you don't need a variable holding the session for running ops. This can be useful in interactive Python environments, like when writing IPython notebooks, for instance.

We've mentioned only a few of the available source operations. [Table 3-2](#) provides short descriptions of more useful initializers.

TensorFlow operation	Description
<code>tf.constant(value)</code>	Creates a tensor populated with the value or values specified by the argument <i>value</i>
<code>tf.fill(shape, value)</code>	Creates a tensor of shape <i>shape</i> and fills it with <i>value</i>
<code>tf.zeros(shape)</code>	Returns a tensor of shape <i>shape</i> with all elements set to 0
<code>tf.zeros_like(tensor)</code>	Returns a tensor of the same type and shape as <i>tensor</i> with all elements set to 0
<code>tf.ones(shape)</code>	Returns a tensor of shape <i>shape</i> with all elements set to 1
<code>tf.ones_like(tensor)</code>	Returns a tensor of the same type and shape as <i>tensor</i> with all elements set to 1
<code>tf.random_normal(shape, mean, stddev)</code>	Outputs random values from a normal distribution
<code>tf.truncated_normal(shape, mean, stddev)</code>	Outputs random values from a truncated normal distribution (values whose magnitude is more than two standard deviations from the mean are dropped and re-picked)
<code>tf.random_uniform(shape, minval, maxval)</code>	Generates values from a uniform distribution in the range [ <i>minval</i> , <i>maxval</i> )
<code>tf.random_shuffle(tensor)</code>	Randomly shuffles a tensor along its first dimension

## Matrix multiplication

This very useful arithmetic operation is performed in TensorFlow via the `tf.matmul(A,B)` function for two Tensor objects A and B.

Say we have a Tensor storing a matrix A and another storing a vector *x*, and we wish to compute the matrix product of the two:

$$Ax = b$$

Before using `matmul()`, we need to make sure both have the same number of dimensions and that they are aligned correctly with respect to the intended multiplication.

In the following example, a matrix A and a vector *x* are created:

```
A = tf.constant([ [1,2,3],
                  [4,5,6] ])
print(a.get_shape())
```

```
x = tf.constant([1,0,1])
print(x.get_shape())
```

```
Out:
(2, 3)
(3,)
```

In order to multiply them, we need to add a dimension to *x*, transforming it from a 1D vector to a 2D single-column matrix.

We can add another dimension by passing the Tensor to `tf.expand_dims()`, together with the position of the added dimension as the second argument. By adding another dimension in the second position (index 1), we get the desired outcome:

```
x = tf.expand_dims(x,1)
print(x.get_shape())

b = tf.matmul(A,x)

sess = tf.InteractiveSession()
print('matmul result:\n {}'.format(b.eval()))
sess.close()
```

```
Out:
(3, 1)
```

```
matmul result:
[[ 4]
 [10]]
```

If we want to flip an array, for example turning a column vector into a row vector or vice versa, we can use the `tf.transpose()` function.

## Names

Each Tensor object also has an identifying name. This name is an intrinsic string name, not to be confused with the name of the variable. As with `dtype`, we can use the `.name` attribute to see the name of the object:

```
with tf.Graph().as_default():
    c1 = tf.constant(4,dtype=tf.float64,name='c')
    c2 = tf.constant(4,dtype=tf.int32,name='c')
print(c1.name)
print(c2.name)
```

```
Out:
c:0
c_1:0
```

The name of the Tensor object is simply the name of its corresponding operation (“c”; concatenated with a colon), followed by the index of that tensor in the outputs of the operation that produced it—it is possible to have more than one.



## Duplicate names

Objects residing within the same graph cannot have the same name —TensorFlow forbids it. As a consequence, it will automatically add an underscore and a number to distinguish the two. Of course, both objects can have the same name when they are associated with different graphs.

## Name scopes

Sometimes when dealing with a large, complicated graph, we would like to create some node grouping to make it easier to follow and manage. For that we can hierarchically group nodes together by name. We do so by using `tf.name_scope("prefix_fix")` together with the useful `with` clause again:

```
with tf.Graph().as_default():
    c1 = tf.constant(4,dtype=tf.float64,name='c')
    with tf.name_scope("prefix_name"):
        c2 = tf.constant(4,dtype=tf.int32,name='c')
        c3 = tf.constant(4,dtype=tf.float64,name='c')
```

```
print(c1.name)
print(c2.name)
print(c3.name)
```

```
Out:
c:0
prefix_name/c:0
prefix_name/c_1:0
```

In this example we've grouped objects contained in variables `c2` and `c3` under the scope `prefix_name`, which shows up as a prefix in their names.

Prefixes are especially useful when we would like to divide a graph into subgraphs with some semantic meaning. These parts can later be used, for instance, for visualization of the graph structure.

# Variables, Placeholders, and Simple Optimization

In this section we will cover two important types of Tensor objects: Variables and placeholders. We then move forward to the main event: optimization. We will briefly talk about all the basic components for optimizing a model, and then do some simple demonstration that puts everything together.

## Variables

The optimization process serves to tune the parameters of some given model. For that purpose, TensorFlow uses special objects called *Variables*. Unlike other Tensor

objects that are “refilled” with data each time we run the session, Variables can maintain a fixed state in the graph. This is important because their current state might influence how they change in the following iteration. Like other Tensors, Variables can be used as input for other operations in the graph.

Using Variables is done in two stages. First we call the `tf.Variable()` function in order to create a Variable and define what value it will be initialized with. We then have to explicitly perform an initialization operation by running the session with the `tf.global_variables_initializer()` method, which allocates the memory for the Variable and sets its initial values.

Like other Tensor objects, Variables are computed only when the model runs, as we can see in the following example:

```
init_val = tf.random_normal((1,5),0,1)
var = tf.Variable(init_val, name='var')
print("pre run: \n{}".format(var))

init = tf.global_variables_initializer()
with tf.Session() as sess:
    sess.run(init)
    post_var = sess.run(var)

print("\npost run: \n{}".format(post_var))

Out:
pre run:
Tensor("var/read:0", shape=(1, 5), dtype=float32)

post run:
[[ 0.85962135  0.64885855  0.25370994 -0.37380791  0.63552463]]
```

Note that if we run the code again, we see that a new variable is created each time, as indicated by the automatic concatenation of `_1` to its name:

```
pre run:
Tensor("var_1/read:0", shape=(1, 5), dtype=float32)
```

This could be very inefficient when we want to reuse the model (complex models could have many variables!); for example, when we wish to feed it with several different inputs. To reuse the same variable, we can use the `tf.get_variables()` function instead of `tf.Variable()`. More on this can be found in [“Model Structuring” on page 203](#) of the appendix.

## Placeholders

So far we’ve used source operations to create our input data. TensorFlow, however, has designated built-in structures for feeding input values. These structures are called *placeholders*. Placeholders can be thought of as empty Variables that will be filled with

data later on. We use them by first constructing our graph and only when it is executed feeding them with the input data.

Placeholders have an optional shape argument. If a shape is not fed or is passed as None, then the placeholder can be fed with data of any size. It is common to use None for the dimension of a matrix that corresponds to the number of samples (usually rows), while having the length of the features (usually columns) fixed:

```
ph = tf.placeholder(tf.float32, shape=(None, 10))
```

Whenever we define a placeholder, we must feed it with some input values or else an exception will be thrown. The input data is passed to the `session.run()` method as a dictionary, where each key corresponds to a placeholder variable name, and the matching values are the data values given in the form of a list or a NumPy array:

```
sess.run(s, feed_dict={x: X_data, w: w_data})
```

Let's see how it looks with another graph example, this time with placeholders for two inputs: a matrix `x` and a vector `w`. These inputs are matrix-multiplied to create a five-unit vector `xw` and added with a constant vector `b` filled with the value `-1`. Finally, the variable `s` takes the maximum value of that vector by using the `tf.reduce_max()` operation. The word *reduce* is used because we are reducing a five-unit vector to a single scalar:

```
x_data = np.random.randn(5, 10)
w_data = np.random.randn(10, 1)

with tf.Graph().as_default():
    x = tf.placeholder(tf.float32, shape=(5, 10))
    w = tf.placeholder(tf.float32, shape=(10, 1))
    b = tf.fill((5, 1), -1.)
    xw = tf.matmul(x, w)

    xwb = xw + b
    s = tf.reduce_max(xwb)
    with tf.Session() as sess:
        outs = sess.run(s, feed_dict={x: x_data, w: w_data})

print("outs = {}".format(outs))
```

```
Out:
outs = 3.06512
```

## Optimization

Now we turn to optimization. We first describe the basics of training a model, giving a short description of each component in the process, and show how it is performed in TensorFlow. We then demonstrate a full working example of an optimization process of a simple regression model.



## Training to predict

We have some target variable  $y$ , which we want to explain using some feature vector  $x$ . To do so, we first choose a model that relates the two. Our training data points will be used for “tuning” the model so that it best captures the desired relation. In the following chapters we focus on deep neural network models, but for now we will settle for a simple regression problem.

Let’s start by describing our regression model:

$$f(x_i) = w^T x_i + b$$

$$y_i = f(x_i) + \varepsilon_i$$

$f(x_i)$  is assumed to be a linear combination of some input data  $x_i$ , with a set of weights  $w$  and an intercept  $b$ . Our target output  $y_i$  is a noisy version of  $f(x_i)$  after being summed with Gaussian noise  $\varepsilon_i$  (where  $i$  denotes a given sample).

As in the previous example, we will need to create the appropriate placeholders for our input and output data and Variables for our weights and intercept:

```
x = tf.placeholder(tf.float32, shape=[None, 3])
y_true = tf.placeholder(tf.float32, shape=None)
w = tf.Variable([[0, 0, 0]], dtype=tf.float32, name='weights')
b = tf.Variable(0, dtype=tf.float32, name='bias')
```

Once the placeholders and Variables are defined, we can write down our model. In this example, it’s simply a multivariate linear regression—our predicted output `y_pred` is the result of a matrix multiplication of our input container `x` and our weights `w` plus a bias term `b`:

```
y_pred = tf.matmul(w, tf.transpose(x)) + b
```

## Defining a loss function

Next, we need a good measure with which we can evaluate the model’s performance. To capture the discrepancy between our model’s predictions and the observed targets, we need a measure reflecting “distance.” This distance is often referred to as an *objective* or a *loss* function, and we optimize the model by finding the set of parameters (weights and bias in this case) that minimize it.

There is no ideal loss function, and choosing the most suitable one is often a blend of art and science. The choice may depend on several factors, like the assumptions of our model, how easy it is to minimize, and what types of mistakes we prefer to avoid.

## MSE and cross entropy

Perhaps the most commonly used loss is the MSE (mean squared error), where for all samples we average the squared distances between the real target and what our model predicts across samples:

$$L(y, \hat{y}) = \frac{1}{n} \sum_{i=1}^n (y_i - \hat{y}_i)^2$$

This loss has intuitive interpretation—it minimizes the mean square difference between an observed value and the model’s fitted value (these differences are referred to as *residuals*).

In our linear regression example, we take the difference between the vector `y_true` ( $y$ ), the true targets, and `y_pred` ( $\hat{y}$ ), the model’s predictions, and use `tf.square()` to compute the square of the difference vector. This operation is applied element-wise. We then average the squared differences using the `tf.reduce_mean()` function:

```
loss = tf.reduce_mean(tf.square(y_true-y_pred))
```

Another very common loss, especially for categorical data, is the *cross entropy*, which we used in the softmax classifier in the previous chapter. The cross entropy is given by

$$H(p,q) = -\sum_x p(x) \log q(x)$$

and for classification with a single correct label (as is the case in an overwhelming majority of the cases) reduces to the negative log of the probability placed by the classifier on the correct label.

In TensorFlow:

```
loss = tf.nn.sigmoid_cross_entropy_with_logits(labels=y_true, logits=y_pred)
```

```
loss = tf.reduce_mean(loss)
```

Cross entropy is a measure of similarity between two distributions. Since the classification models used in deep learning typically output probabilities for each class, we can compare the true class (distribution  $p$ ) with the probabilities of each class given by the model (distribution  $q$ ). The more similar the two distributions, the smaller our cross entropy will be.

## The gradient descent optimizer

The next thing we need to figure out is how to minimize the loss function. While in some cases it is possible to find the global minimum analytically (when it exists), in the great majority of cases we will have to use an optimization algorithm. Optimizers update the set of weights iteratively in a way that decreases the loss over time.

The most commonly used approach is gradient descent, where we use the loss’s gradient with respect to the set of weights. In slightly more technical terms, if our loss is some multivariate function  $F(\vec{w})$ , then in the neighborhood of some point  $\vec{w}_0$ , the “steepest” direction of decrease of  $F(\vec{w})$  is obtained by moving from  $\vec{w}_0$  in the direction of the negative gradient of  $F$  at  $\vec{w}_0$ .

So if  $\bar{w}_1 = \bar{w}_0 - \gamma \nabla F(\bar{w}_0)$  where  $\nabla F(\bar{w}_0)$  is the gradient of  $F$  evaluated at  $\bar{w}_0$ , then for a small enough  $\gamma$ :

$$F(\bar{w}_0) \geq F(\bar{w}_1)$$

The gradient descent algorithms work well on highly complicated network architectures and therefore are suitable for a wide variety of problems. More specifically, recent advances make it possible to compute these gradients by utilizing massively parallel systems, so the approach scales well with dimensionality (though it can still be painfully time-consuming for large real-world problems). While convergence to the global minimum is guaranteed for convex functions, for nonconvex problems (which are essentially all problems in the world of deep learning) they can get stuck in local minima. In practice, this is often good enough, as is evidenced by the huge success of the field of deep learning.

### Sampling methods

The gradient of the objective is computed with respect to the model parameters and evaluated using a given set of input samples,  $x_i$ . How many of the samples should we take for this calculation? Intuitively, it makes sense to calculate the gradient for the entire set of samples in order to benefit from the maximum amount of available information. This method, however, has some shortcomings. For example, it can be very slow and is intractable when the dataset requires more memory than is available.

A more popular technique is the stochastic gradient descent (SGD), where instead of feeding the entire dataset to the algorithm for the computation of each step, a subset of the data is sampled sequentially. The number of samples ranges from one sample at a time to a few hundred, but the most common sizes are between around 50 to around 500 (usually referred to as *mini-batches*).

Using smaller batches usually works faster, and the smaller the size of the batch, the faster are the calculations. However, there is a trade-off in that small samples lead to lower hardware utilization and tend to have high variance, causing large fluctuations to the objective function. Nevertheless, it turns out that some fluctuations are beneficial since they enable the set of parameters to jump to new and potentially better local minima. Using a relatively smaller batch size is therefore effective in that regard, and is currently overall the preferred approach.

### Gradient descent in TensorFlow

TensorFlow makes it very easy and intuitive to use gradient descent algorithms. Optimizers in TensorFlow compute the gradients simply by adding new operations to the graph, and the gradients are calculated using automatic differentiation. This means, in general terms, that TensorFlow automatically computes the gradients on its own, “deriving” them from the operations and structure of the computation graph.

An important parameter to set is the algorithm's learning rate, determining how aggressive each update iteration will be (or in other words, how large the step will be in the direction of the negative gradient). We want the decrease in the loss to be fast enough on the one hand, but on the other hand not large enough so that we overshoot the target and end up at a point with a higher value of the loss function.

We first create an optimizer by using the `GradientDescentOptimizer()` function with the desired learning rate. We then create a train operation that updates our variables by calling the `optimizer.minimize()` function and passing in the loss as an argument:

```
optimizer = tf.train.GradientDescentOptimizer(learning_rate)
train = optimizer.minimize(loss)
```

The train operation is then executed when it is fed to the `sess.run()` method.

### Wrapping it up with examples

We're all set to go! Let's combine all the components we've discussed in this section and optimize the parameters of two models: linear and logistic regression. In these examples we will create synthetic data with known properties, and see how the model is able to recover these properties with the process of optimization.

**Example 1: linear regression.** In this problem we are interested in retrieving a set of weights  $w$  and a bias term  $b$ , assuming our target value is a linear combination of some input vector  $x$ , with an additional Gaussian noise  $\epsilon_i$  added to each sample.

For this exercise we will generate synthetic data using NumPy. We create 2,000 samples of  $x$ , a vector with three features, take the inner product of each  $x$  sample with a set of weights  $w$  ([0.3, 0.5, 0.1]), and add a bias term  $b$  (-0.2) and Gaussian noise to the result:

```
import numpy as np
# === Create data and simulate results =====
x_data = np.random.randn(2000,3)
w_real = [0.3,0.5,0.1]
b_real = -0.2

noise = np.random.randn(1,2000)*0.1
y_data = np.matmul(w_real,x_data.T) + b_real + noise
```

The noisy samples are shown in [Figure 3-6](#).

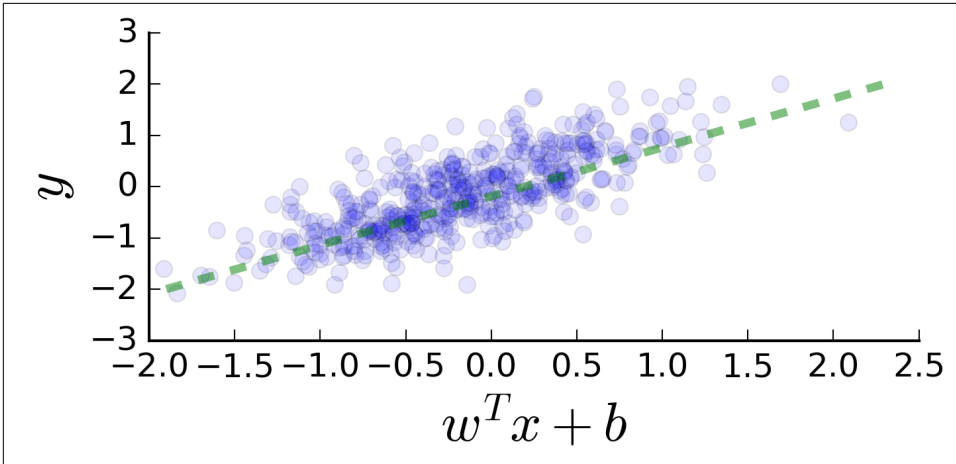

Figure 3-6. Generated data to use for linear regression: each filled circle represents a sample, and the dashed line shows the expected values without the noise component (the diagonal).

Next, we estimate our set of weights  $w$  and bias  $b$  by optimizing the model (i.e., finding the best parameters) so that its predictions match the real targets as closely as possible. Each iteration computes one update to the current parameters. In this example we run 10 iterations, printing our estimated parameters every 5 iterations using the `sess.run()` method.

Don't forget to initialize the variables! In this example we initialize both the weights and the bias with zeros; however, there are “smarter” initialization techniques to choose, as we will see in the next chapters. We use name scopes to group together parts that are related to inferring the output, defining the loss, and setting and creating the train object:

```
NUM_STEPS = 10

g = tf.Graph()
wb_ = []
with g.as_default():
    x = tf.placeholder(tf.float32, shape=[None, 3])
    y_true = tf.placeholder(tf.float32, shape=None)

    with tf.name_scope('inference') as scope:
        w = tf.Variable([[0, 0, 0]], dtype=tf.float32, name='weights')
        b = tf.Variable(0, dtype=tf.float32, name='bias')
        y_pred = tf.matmul(w, tf.transpose(x)) + b

    with tf.name_scope('loss') as scope:
        loss = tf.reduce_mean(tf.square(y_true - y_pred))
```

```

with tf.name_scope('train') as scope:
    learning_rate = 0.5
    optimizer = tf.train.GradientDescentOptimizer(learning_rate)
    train = optimizer.minimize(loss)

# Before starting, initialize the variables. We will 'run' this first.
init = tf.global_variables_initializer()
with tf.Session() as sess:
    sess.run(init)
    for step in range(NUM_STEPS):
        sess.run(train, {x: x_data, y_true: y_data})
        if (step % 5 == 0):
            print(step, sess.run([w,b]))
            wb_.append(sess.run([w,b]))

    print(10, sess.run([w,b]))

```

And we get the results:

```

(0, [array([[ 0.30149955,  0.49303722,  0.11409992]],
           dtype=float32), -0.18563795])

(5, [array([[ 0.30094019,  0.49846715,  0.09822173]],
           dtype=float32), -0.19780949])

(10, [array([[ 0.30094025,  0.49846718,  0.09822182]],
           dtype=float32), -0.19780946])

```

After only 10 iterations, the estimated weights and bias are  $\hat{w} = [0.301, 0.498, 0.098]$  and  $\hat{b} = -0.198$ . The original parameter values were  $w = [0.3, 0.5, 0.1]$  and  $b = -0.2$ .

Almost a perfect match!

**Example 2: logistic regression.** Again we wish to retrieve the weights and bias components in a simulated data setting, this time in a logistic regression framework. Here the linear component  $w^T x + b$  is the input of a nonlinear function called the logistic function. What it effectively does is squash the values of the linear part into the interval  $[0, 1]$ :

$$Pr(y_i = 1|x_i) = \frac{1}{1 + \exp^{-wx_i + b}}$$

We then regard these values as probabilities from which binary yes/1 or no/0 outcomes are generated. This is the nondeterministic (noisy) part of the model.

The logistic function is more general, and can be used with a different set of parameters for the steepness of the curve and its maximum value. This special case of a logistic function we are using is also referred to as a *sigmoid function*.

We generate our samples by using the same set of weights and biases as in the previous example:

```

N = 20000

def sigmoid(x):
    return 1 / (1 + np.exp(-x))
# === Create data and simulate results ===
x_data = np.random.randn(N,3)
w_real = [0.3,0.5,0.1]
b_real = -0.2
wxb = np.matmul(w_real,x_data.T) + b_real

y_data_pre_noise = sigmoid(wxb)
y_data = np.random.binomial(1,y_data_pre_noise)

```

The outcome samples before and after the binarization of the output are shown in Figure 3-7.

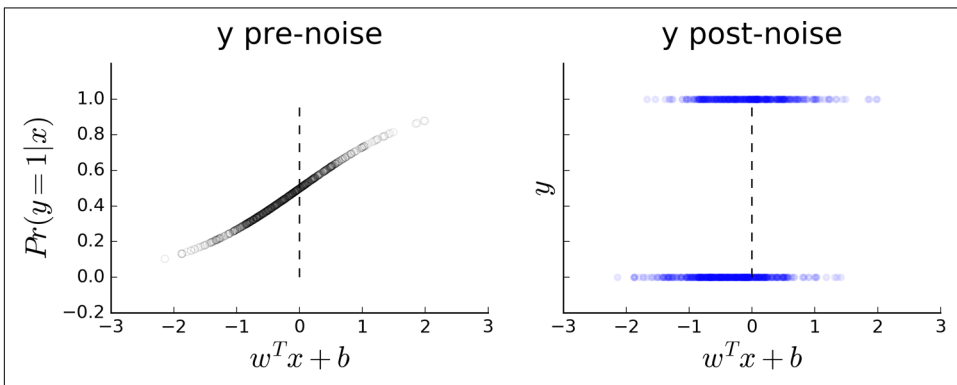

Figure 3-7. Generated data to use for logistic regression: each circle represents a sample. In the left plot we see the probabilities generated by inputting the linear combination of the input data to the logistic function. The right plot shows the binary target output, randomly sampled from the probabilities in the left image.

The only thing we need to change in the code is the loss function we use.

The loss we want to use here is the binary version of the cross entropy, which is also the likelihood of the logistic regression model:

```

y_pred = tf.sigmoid(y_pred)
loss = y_true*tf.log(y_pred) - (1-y_true)*tf.log(1-y_pred)
loss = tf.reduce_mean(loss)

```

Luckily, TensorFlow already has a designated function we can use instead:

```

tf.nn.sigmoid_cross_entropy_with_logits(labels=,logits=)

```

To which we simply need to pass the true outputs and the model's linear predictions:

```
NUM_STEPS = 50

with tf.name_scope('loss') as scope:
    loss = tf.nn.sigmoid_cross_entropy_with_logits(labels=y_true, logits=y_pred)
    loss = tf.reduce_mean(loss)

# Before starting, initialize the variables. We will 'run' this first.
init = tf.global_variables_initializer()
with tf.Session() as sess:
    sess.run(init)
    for step in range(NUM_STEPS):
        sess.run(train, {x: x_data, y_true: y_data})
        if (step % 5 == 0):
            print(step, sess.run([w,b]))
            wb_.append(sess.run([w,b]))

print(50, sess.run([w,b]))
```

Let's see what we get:

```
(0, [array([[ 0.03212515,  0.05890014,  0.01086476]],
            dtype=float32), -0.021875083])
(5, [array([[ 0.14185661,  0.25990966,  0.04818931]],
            dtype=float32), -0.097346731])
(10, [array([[ 0.20022796,  0.36665651,  0.06824245]],
            dtype=float32), -0.13804035])
(15, [array([[ 0.23269908,  0.42593899,  0.07949805]],
            dtype=float32), -0.1608445])
(20, [array([[ 0.2512995 ,  0.45984453,  0.08599731]],
            dtype=float32), -0.17395383])
(25, [array([[ 0.26214141,  0.47957924,  0.08981277]],
            dtype=float32), -0.1816061])
(30, [array([[ 0.26852587,  0.49118528,  0.09207394]],
            dtype=float32), -0.18611355])
(35, [array([[ 0.27230808,  0.49805275,  0.09342111]],
            dtype=float32), -0.18878292])
(40, [array([[ 0.27455658,  0.50213116,  0.09422609]],
            dtype=float32), -0.19036882])
(45, [array([[ 0.27589601,  0.5045585 ,  0.09470785]],
            dtype=float32), -0.19131286])
(50, [array([[ 0.27656636,  0.50577223,  0.09494986]],
            dtype=float32), -0.19178495])
```

It takes a few more iterations to converge, and more samples are required than in the previous linear regression example, but eventually we get results that are quite similar to the original chosen weights.



## Summary

In this chapter we learned about computation graphs and what we can use them for. We saw how to create a graph and how to compute its outputs. We introduced the main building blocks of TensorFlow—the Tensor object, representing the graph's operations, placeholders for our input data, and Variables we tune as part of the model training process. We learned about tensor arrays and covered the data type, shape, and name attributes. Finally, we discussed the model optimization process and saw how to implement it in TensorFlow. In the next chapter we will go into more advanced deep neural networks used in computer vision.



---

# Convolutional Neural Networks

In this chapter we introduce convolutional neural networks (CNNs) and the building blocks and methods associated with them. We start with a simple model for classification of the MNIST dataset, then we introduce the CIFAR10 object-recognition dataset and apply several CNN models to it. While small and fast, the CNNs presented in this chapter are highly representative of the type of models used in practice to obtain state-of-the-art results in object-recognition tasks.

## Introduction to CNNs

Convolutional neural networks have gained a special status over the last few years as an especially promising form of deep learning. Rooted in image processing, convolutional layers have found their way into virtually all subfields of deep learning, and are very successful for the most part.

The fundamental difference between *fully connected* and *convolutional* neural networks is the pattern of connections between consecutive layers. In the fully connected case, as the name might suggest, each unit is connected to all of the units in the previous layer. We saw an example of this in [Chapter 2](#), where the 10 output units were connected to all of the input image pixels.

In a convolutional layer of a neural network, on the other hand, each unit is connected to a (typically small) number of nearby units in the previous layer. Furthermore, all units are connected to the previous layer in the same way, with the exact same weights and structure. This leads to an operation known as *convolution*, giving the architecture its name (see [Figure 4-1](#) for an illustration of this idea). In the next section, we go into the convolution operation in some more detail, but in a nutshell all it means for us is applying a small “window” of weights (also known as *filters*) across an image, as illustrated in [Figure 4-2](#) later.

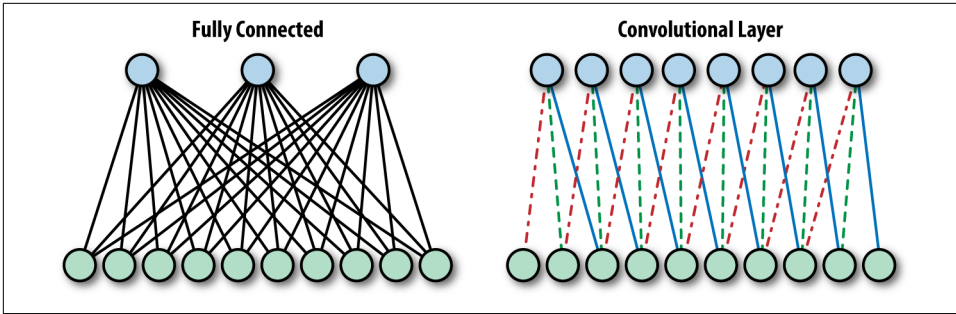

Figure 4-1. In a fully connected layer (left), each unit is connected to all units of the previous layers. In a convolutional layer (right), each unit is connected to a constant number of units in a local region of the previous layer. Furthermore, in a convolutional layer, the units all share the weights for these connections, as indicated by the shared linetypes.

There are motivations commonly cited as leading to the CNN approach, coming from different schools of thought. The first angle is the so-called neuroscientific inspiration behind the model. The second deals with insight into the nature of images, and the third relates to learning theory. We will go over each of these shortly before diving into the actual mechanics.

It has been popular to describe neural networks in general, and specifically convolutional neural networks, as biologically inspired models of computation. At times, claims go as far as to state that these *mimic the way the brain performs computations*. While misleading when taken at face value, the biological analogy is of some interest.

The Nobel Prize–winning neurophysiologists Hubel and Wiesel discovered as early as the 1960s that the first stages of visual processing in the brain consist of application of the same local filter (e.g., edge detectors) to all parts of the visual field. The current understanding in the neuroscientific community is that as visual processing proceeds, information is integrated from increasingly wider parts of the input, and this is done hierarchically.

Convolutional neural networks follow the same pattern. Each convolutional layer looks at an increasingly larger part of the image as we go deeper into the network. Most commonly, this will be followed by fully connected layers that in the biologically inspired analogy act as the higher levels of visual processing dealing with global information.

The second angle, more hard fact engineering–oriented, stems from the nature of images and their contents. When looking for an object in an image, say the face of a cat, we would typically want to be able to detect it regardless of its position in the image. This reflects the property of natural images that the same content may be found in different locations of an image. This is property is known as an *invariance*—

invariances of this sort can also be expected with respect to (small) rotations, changing lighting conditions, etc.

Correspondingly, when building an object-recognition system, it should be invariant to translation (and, depending on the scenario, probably also rotation and deformations of many sorts, but that is another matter). Put simply, it therefore makes sense to perform the same exact computation on different parts of the image. In this view, a convolutional neural network layer computes the same features of an image, across all spatial areas.

Finally, the convolutional structure can be seen as a regularization mechanism. In this view, convolutional layers are like fully connected layers, but instead of searching for weights in the full space of matrices (of certain size), we limit the search to matrices describing fixed-size convolutions, reducing the number of degrees of freedom to the size of the convolution, which is typically very small.



### Regularization

The term *regularization* is used throughout this book. In machine learning and statistics, regularization is mostly used to refer to the restriction of an optimization problem by imposing a penalty on the complexity of the solution, in the attempt to prevent overfitting to the given examples.

Overfitting occurs when a rule (for instance, a classifier) is computed in a way that explains the training set, but with poor generalization to unseen data.

Regularization is most often applied by adding implicit information regarding the desired results (this could take the form of saying we would rather have a smoother function, when searching a function space). In the convolutional neural network case, we explicitly state that we are looking for weights in a relatively low-dimensional subspace corresponding to fixed-size convolutions.

In this chapter we cover the types of layers and operations associated with convolutional neural networks. We start by revisiting the MNIST dataset, this time applying a model with approximately 99% accuracy. Next, we move on to the more interesting object recognition CIFAR10 dataset.

## MNIST: Take II

In this section we take a second look at the MNIST dataset, this time applying a small convolutional neural network as our classifier. Before doing so, there are several elements and operations that we must get acquainted with.

## Convolution

The convolution operation, as you probably expect from the name of the architecture, is the fundamental means by which layers are connected in convolutional neural networks. We use the built-in TensorFlow `conv2d()`:

```
tf.nn.conv2d(x, W, strides=[1, 1, 1, 1], padding='SAME')
```

Here,  $x$  is the data—the input image, or a downstream feature map obtained further along in the network, after applying previous convolution layers. As discussed previously, in typical CNN models we stack convolutional layers hierarchically, and *feature map* is simply a commonly used term referring to the output of each such layer. Another way to view the output of these layers is as *processed images*, the result of applying a filter and perhaps some other operations. Here, this filter is parameterized by  $W$ , the learned weights of our network representing the convolution filter. This is just the set of weights in the small “sliding window” we see in [Figure 4-2](#).

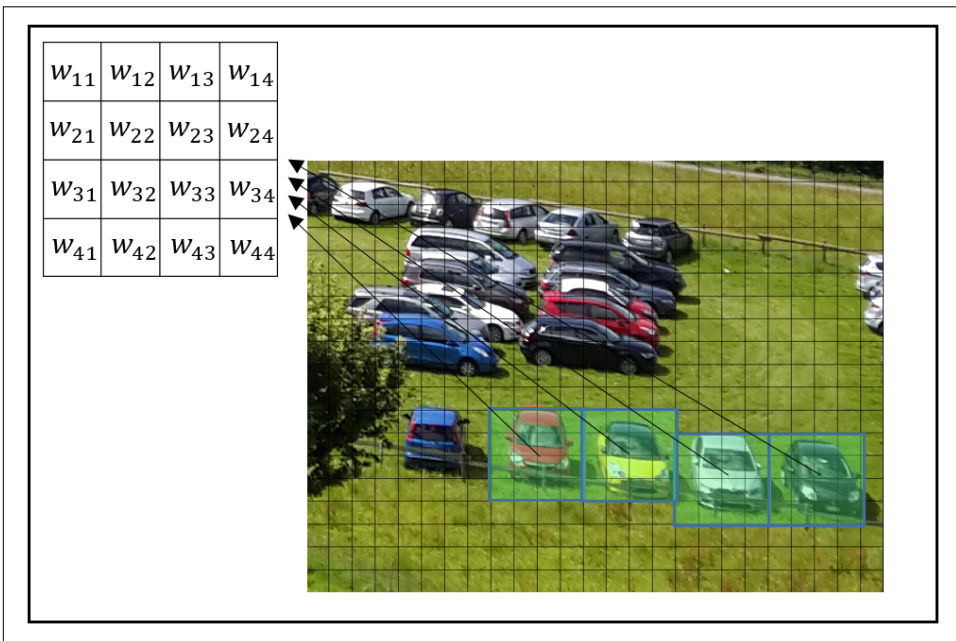

Figure 4-2. The same convolutional filter—a “sliding window”—applied across an image.

The output of this operation will depend on the shape of  $x$  and  $W$ , and in our case is four-dimensional. The image data  $x$  will be of shape:

```
[None, 28, 28, 1]
```

meaning that we have an unknown number of images, each  $28 \times 28$  pixels and with one color channel (since these are grayscale images). The weights  $W$  we use will be of shape:

```
[5, 5, 1, 32]
```

where the initial  $5 \times 5 \times 1$  represents the size of the small “window” in the image to be convolved, in our case a  $5 \times 5$  region. In images that have multiple color channels (RGB, as briefly discussed in [Chapter 1](#)), we regard each image as a three-dimensional tensor of RGB values, but in this one-channel data they are just two-dimensional, and convolutional filters are applied to two-dimensional regions. Later, when we tackle the CIFAR10 data, we’ll see examples of multiple-channel images and how to set the size of weights  $W$  accordingly.

The final 32 is the number of feature maps. In other words, we have multiple sets of weights for the convolutional layer—in this case, 32 of them. Recall that the idea of a convolutional layer is to compute the same feature along the image; we would simply like to compute many such features and thus use multiple sets of convolutional filters.

The `strides` argument controls the spatial movement of the filter  $W$  across the image (or feature map)  $x$ .

The value `[1, 1, 1, 1]` means that the filter is applied to the input in one-pixel intervals in each dimension, corresponding to a “full” convolution. Other settings of this argument allow us to introduce skips in the application of the filter—a common practice that we apply later—thus making the resulting feature map smaller.

Finally, setting `padding` to `'SAME'` means that the borders of  $x$  are padded such that the size of the result of the operation is the same as the size of  $x$ .



## Activation functions

Following linear layers, whether convolutional or fully connected, it is common practice to apply nonlinear *activation functions* (see [Figure 4-3](#) for some examples). One practical aspect of activation functions is that consecutive linear operations can be replaced by a single one, and thus depth doesn't contribute to the expressiveness of the model unless we use nonlinear activations between the linear layers.

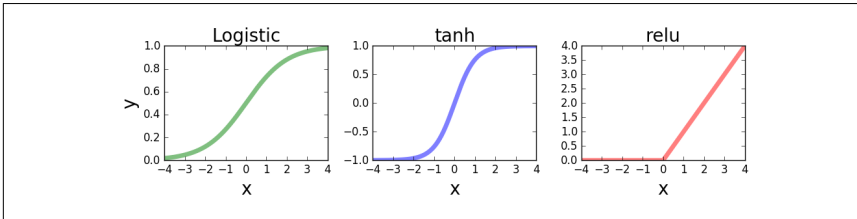

Figure 4-3. Common activation functions: logistic (left), hyperbolic tangent (center), and rectifying linear unit (right)

## Pooling

It is common to follow convolutional layers with pooling of outputs. Technically, *pooling* means reducing the size of the data with some local aggregation function, typically within each feature map.

The reasoning behind this is both technical and more theoretical. The technical aspect is that pooling reduces the size of the data to be processed downstream. This can drastically reduce the number of overall parameters in the model, especially if we use fully connected layers after the convolutional ones.

The more theoretical reason for applying pooling is that we would like our computed features not to care about small changes in position in an image. For instance, a feature looking for eyes in the top-right part of an image should not change too much if we move the camera a bit to the right when taking the picture, moving the eyes slightly to the center of the image. Aggregating the “eye-detector feature” spatially allows the model to overcome such spatial variability between images, capturing some form of invariance as discussed at the beginning of this chapter.

In our example we apply the max pooling operation on  $2 \times 2$  blocks of each feature map:

```
tf.nn.max_pool(x, ksize=[1, 2, 2, 1], strides=[1, 2, 2, 1], padding='SAME')
```

Max pooling outputs the maximum of the input in each region of a predefined size (here  $2 \times 2$ ). The `ksize` argument controls the size of the pooling ( $2 \times 2$ ), and the `strides` argument controls by how much we “slide” the pooling grids across `x`, just as



in the case of the convolution layer. Setting this to a  $2 \times 2$  grid means that the output of the pooling will be exactly one-half of the height and width of the original, and in total one-quarter of the size.

## Dropout

The final element we will need for our model is *dropout*. This is a regularization trick used in order to force the network to distribute the learned representation across all the neurons. Dropout “turns off” a random preset fraction of the units in a layer, by setting their values to zero during training. These dropped-out neurons are random—different for each computation—forcing the network to learn a representation that will work even after the dropout. This process is often thought of as training an “ensemble” of multiple networks, thereby increasing generalization. When using the network as a classifier at test time (“inference”), there is no dropout and the full network is used as is.

The only argument in our example other than the layer we would like to apply dropout to is `keep_prob`, the fraction of the neurons to keep working at each step:

```
tf.nn.dropout(layer, keep_prob=keep_prob)
```

In order to be able to change this value (which we must do, since for testing we would like this to be `1.0`, meaning no dropout at all), we will use a `tf.Variable` and pass one value for train (`.5`) and another for test (`1.0`).

## The Model

First, we define helper functions that will be used extensively throughout this chapter to create our layers. Doing this allows the actual model to be short and readable (later in the book we will see that there exist several frameworks for greater abstraction of deep learning building blocks, which allow us to concentrate on rapidly designing our networks rather than the somewhat tedious work of defining all the necessary elements). Our helper functions are:

```
def weight_variable(shape):
    initial = tf.truncated_normal(shape, stddev=0.1)
    return tf.Variable(initial)

def bias_variable(shape):
    initial = tf.constant(0.1, shape=shape)
    return tf.Variable(initial)

def conv2d(x, W):
    return tf.nn.conv2d(x, W, strides=[1, 1, 1, 1], padding='SAME')
```

```

def max_pool_2x2(x):
    return tf.nn.max_pool(x, ksize=[1, 2, 2, 1],
                          strides=[1, 2, 2, 1], padding='SAME')

def conv_layer(input, shape):
    W = weight_variable(shape)
    b = bias_variable([shape[3]])
    return tf.nn.relu(conv2d(input, W) + b)

def full_layer(input, size):
    in_size = int(input.get_shape()[1])
    W = weight_variable([in_size, size])
    b = bias_variable([size])
    return tf.matmul(input, W) + b

```

Let's take a closer look at these:

`weight_variable()`

This specifies the weights for either fully connected or convolutional layers of the network. They are initialized randomly using a truncated normal distribution with a standard deviation of .1. This sort of initialization with a random normal distribution that is truncated at the tails is pretty common and generally produces good results (see the upcoming note on random initialization).

`bias_variable()`

This defines the bias elements in either a fully connected or a convolutional layer. These are all initialized with the constant value of .1.

`conv2d()`

This specifies the convolution we will typically use. A full convolution (no skips) with an output the same size as the input.

`max_pool_2x2`

This sets the max pool to half the size across the height/width dimensions, and in total a quarter the size of the feature map.

`conv_layer()`

This is the actual layer we will use. Linear convolution as defined in `conv2d`, with a bias, followed by the ReLU nonlinearity.

`full_layer()`

A standard full layer with a bias. Notice that here we didn't add the ReLU. This allows us to use the same layer for the final output, where we don't need the non-linear part.

With these layers defined, we are ready to set up our model (see the visualization in [Figure 4-4](#)):

```

x = tf.placeholder(tf.float32, shape=[None, 784])
y_ = tf.placeholder(tf.float32, shape=[None, 10])

x_image = tf.reshape(x, [-1, 28, 28, 1])
conv1 = conv_layer(x_image, shape=[5, 5, 1, 32])
conv1_pool = max_pool_2x2(conv1)

conv2 = conv_layer(conv1_pool, shape=[5, 5, 32, 64])
conv2_pool = max_pool_2x2(conv2)

conv2_flat = tf.reshape(conv2_pool, [-1, 7*7*64])
full_1 = tf.nn.relu(full_layer(conv2_flat, 1024))

keep_prob = tf.placeholder(tf.float32)
full1_drop = tf.nn.dropout(full_1, keep_prob=keep_prob)

y_conv = full_layer(full1_drop, 10)

```

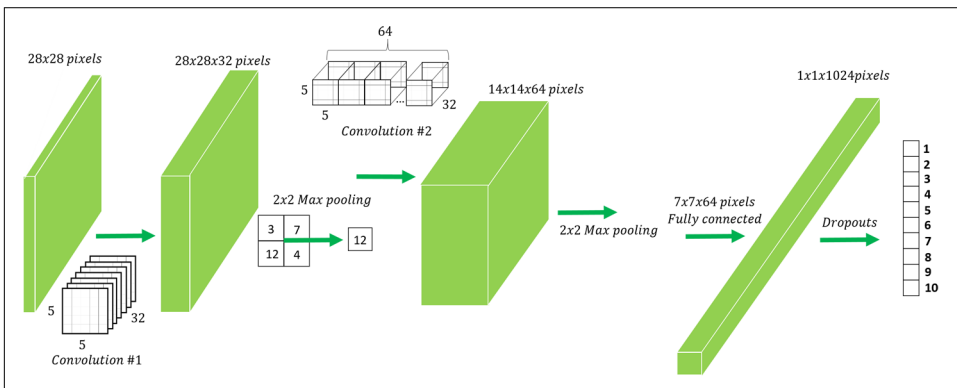

Figure 4-4. A visualization of the CNN architecture used.



### Random initialization

In the previous chapter we discussed initializers of several types, including the random initializer used here for our convolutional layer’s weights:

```
initial = tf.truncated_normal(shape, stddev=0.1)
```

Much has been said about the importance of initialization in the training of deep learning models. Put simply, a bad initialization can make the training process “get stuck,” or fail completely due to numerical issues. Using random rather than constant initializations helps break the symmetry between learned features, allowing the model to learn a diverse and rich representation. Using bound values helps, among other things, to control the magnitude of the gradients, allowing the network to converge more efficiently.

We start by defining the placeholders for the images and correct labels, `x` and `y_`, respectively. Next, we reshape the image data into the 2D image format with size  $28 \times 28 \times 1$ . Recall we did not need this spatial aspect of the data for our previous MNIST model, since all pixels were treated independently, but a major source of power in the convolutional neural network framework is the utilization of this spatial meaning when considering images.

Next we have two consecutive layers of convolution and pooling, each with  $5 \times 5$  convolutions and 64 feature maps, followed by a single fully connected layer with 1,024 units. Before applying the fully connected layer we flatten the image back to a single vector form, since the fully connected layer no longer needs the spatial aspect.

Notice that the size of the image following the two convolution and pooling layers is  $7 \times 7 \times 64$ . The original  $28 \times 28$  pixel image is reduced first to  $14 \times 14$ , and then to  $7 \times 7$  in the two pooling operations. The 64 is the number of feature maps we created in the second convolutional layer. When considering the total number of learned parameters in the model, a large proportion will be in the fully connected layer (going from  $7 \times 7 \times 64$  to 1,024 gives us 3.2 million parameters). This number would have been 16 times as large (i.e.,  $28 \times 28 \times 64 \times 1,024$ , which is roughly 51 million) if we hadn't used max-pooling.

Finally, the output is a fully connected layer with 10 units, corresponding to the number of labels in the dataset (recall that MNIST is a handwritten digit dataset, so the number of possible labels is 10).

The rest is the same as in the first MNIST model in [Chapter 2](#), with a few minor changes:

#### `train_accuracy`

We print the accuracy of the model on the batch used for training every 100 steps. This is done *before* the training step, and therefore is a good estimate of the current performance of the model on the training set.

#### `test_accuracy`

We split the test procedure into 10 blocks of 1,000 images each. Doing this is important mostly for much larger datasets.

Here's the complete code:

```
mnist = input_data.read_data_sets(DATA_DIR, one_hot=True)

cross_entropy = tf.reduce_mean(tf.nn.softmax_cross_entropy_with_logits(y_conv,
                                                                    y_))
train_step = tf.train.AdamOptimizer(1e-4).minimize(cross_entropy)

correct_prediction = tf.equal(tf.argmax(y_conv, 1), tf.argmax(y_, 1))
accuracy = tf.reduce_mean(tf.cast(correct_prediction, tf.float32))
```

```

with tf.Session() as sess:
    sess.run(tf.global_variables_initializer())

    for i in range(STEPS):
        batch = mnist.train.next_batch(50)

        if i % 100 == 0:
            train_accuracy = sess.run(accuracy, feed_dict={x: batch[0],
                                                            y_: batch[1],
                                                            keep_prob: 1.0})
            print "step {}, training accuracy {}".format(i, train_accuracy)

        sess.run(train_step, feed_dict={x: batch[0], y_: batch[1],
                                         keep_prob: 0.5})

    X = mnist.test.images.reshape(10, 1000, 784)
    Y = mnist.test.labels.reshape(10, 1000, 10)
    test_accuracy = np.mean([sess.run(accuracy,
                                       feed_dict={x:X[i], y_:Y[i],keep_prob:1.0})
                              for i in range(10)])

    print "test accuracy: {}".format(test_accuracy)

```

The performance of this model is already relatively good, with just over 99% correct after as little as 5 epochs,<sup>1</sup> which are 5,000 steps with mini-batches of size 50.

For a list of models that have been used over the years with this dataset, and some ideas on how to further improve this result, take a look at <http://yann.lecun.com/exdb/mnist/>.

## CIFAR10

*CIFAR10* is another dataset with a long history in computer vision and machine learning. Like MNIST, it is a common benchmark that various methods are tested against. **CIFAR10** is a set of 60,000 color images of size 32×32 pixels, each belonging to one of ten categories: airplane, automobile, bird, cat, deer, dog, frog, horse, ship, and truck.

State-of-the-art deep learning methods for this dataset are as good as humans at classifying these images. In this section we start off with much simpler methods that will run relatively quickly. Then, we discuss briefly what the gap is between these and the state of the art.

---

<sup>1</sup> In machine learning and especially in deep learning, an *epoch* refers to a single pass over all the training data; i.e., when the learning model has seen each training example exactly one time.

## Loading the CIFAR10 Dataset

In this section we build a data manager for CIFAR10, similarly to the built-in `input_data.read_data_sets()` we used for MNIST.<sup>2</sup>

First, [download the Python version of the dataset](#) and extract the files into a local directory. You should now have the following files:

- `data_batch_1`, `data_batch_2`, `data_batch_3`, `data_batch_4`, `data_batch_5`
- `test_batch`
- `batches_meta`
- `readme.html`

The `data_batch_X` files are serialized data files containing the training data, and `test_batch` is a similar serialized file containing the test data. The `batches_meta` file contains the mapping from numeric to semantic labels. The `.html` file is a copy of the CIFAR-10 dataset's web page.

Since this is a relatively small dataset, we load it all into memory:

```
class CifarLoader(object):
    def __init__(self, source_files):
        self._source = source_files
        self._i = 0
        self.images = None
        self.labels = None

    def load(self):
        data = [unpickle(f) for f in self._source]
        images = np.vstack([d["data"] for d in data])
        n = len(images)
        self.images = images.reshape(n, 3, 32, 32).transpose(0, 2, 3, 1)\
            .astype(float) / 255
        self.labels = one_hot(np.hstack([d["labels"] for d in data]), 10)
        return self

    def next_batch(self, batch_size):
        x, y = self.images[self._i:self._i+batch_size],
            self.labels[self._i:self._i+batch_size]
        self._i = (self._i + batch_size) % len(self.images)
        return x, y
```

where we use the following utility functions:

```
DATA_PATH = "/path/to/CIFAR10"
```

---

<sup>2</sup> This is done mostly for the purpose of illustration. There are existing open source libraries containing this sort of data wrapper built in, for many popular datasets. See, for example, the `datasets` module in Keras (`keras.datasets`), and specifically `keras.datasets.cifar10`.

```

def unpickle(file):
    with open(os.path.join(DATA_PATH, file), 'rb') as fo:
        dict = cPickle.load(fo)
    return dict

def one_hot(vec, vals=10):
    n = len(vec)
    out = np.zeros((n, vals))
    out[range(n), vec] = 1
    return out

```

The `unpickle()` function returns a `dict` with fields `data` and `labels`, containing the image data and the labels, respectively. `one_hot()` recodes the labels from integers (in the range 0 to 9) to vectors of length 10, containing all 0s except for a 1 at the position of the label.

Finally, we create a data manager that includes both the training and test data:

```

class CifarDataManager(object):
    def __init__(self):
        self.train = CifarLoader(["data_batch_{}".format(i)
                                  for i in range(1, 6)])
        self.train.load()
        self.test = CifarLoader(["test_batch"]).load()

```

Using Matplotlib, we can now use the data manager in order to display some of the CIFAR10 images and get a better idea of what is in this dataset:

```

def display_cifar(images, size):
    n = len(images)
    plt.figure()
    plt.gca().set_axis_off()
    im = np.vstack([np.hstack([images[np.random.choice(n)] for i in range(size)])
                    for i in range(size)])
    plt.imshow(im)
    plt.show()

d = CifarDataManager()
print "Number of train images: {}".format(len(d.train.images))
print "Number of train labels: {}".format(len(d.train.labels))
print "Number of test images: {}".format(len(d.test.images))
print "Number of test labels: {}".format(len(d.test.labels))
images = d.train.images
display_cifar(images, 10)

```



## Matplotlib

*Matplotlib* is a useful Python library for plotting, designed to look and behave like MATLAB plots. It is often the easiest way to quickly plot and visualize a dataset.

The `display_cifar()` function takes as arguments `images` (an iterable containing images), and `size` (the number of images we would like to display), and constructs and displays a `size×size` grid of images. This is done by concatenating the actual images vertically and horizontally to form a large image.

Before displaying the image grid, we start by printing the sizes of the train/test sets. CIFAR10 contains 50K training images and 10K test images:

```
Number of train images: 50000
Number of train labels: 50000
Number of test images: 10000
Number of test labels: 10000
```

The image produced and shown in [Figure 4-5](#) is meant to give some idea of what CIFAR10 images actually look like. Notably, these small,  $32\times 32$  pixel images each contain a full single object that is both centered and more or less recognizable even at this resolution.



*Figure 4-5. 100 random CIFAR10 images.*

## Simple CIFAR10 Models

We will start by using the model that we have previously used successfully for the MNIST dataset. Recall that the MNIST dataset is composed of  $28\times 28$ -pixel grayscale images, while the CIFAR10 images are color images with  $32\times 32$  pixels. This will necessitate minor adaptations to the setup of the computation graph:



```

cifar = CifarDataManager()

x = tf.placeholder(tf.float32, shape=[None, 32, 32, 3])
y_ = tf.placeholder(tf.float32, shape=[None, 10])
keep_prob = tf.placeholder(tf.float32)

conv1 = conv_layer(x, shape=[5, 5, 3, 32])
conv1_pool = max_pool_2x2(conv1)

conv2 = conv_layer(conv1_pool, shape=[5, 5, 32, 64])
conv2_pool = max_pool_2x2(conv2)
conv2_flat = tf.reshape(conv2_pool, [-1, 8 * 8 * 64])

full_1 = tf.nn.relu(full_layer(conv2_flat, 1024))
full1_drop = tf.nn.dropout(full_1, keep_prob=keep_prob)

y_conv = full_layer(full1_drop, 10)

cross_entropy = tf.reduce_mean(tf.nn.softmax_cross_entropy_with_logits(y_conv,
                                                                    y_))
train_step = tf.train.AdamOptimizer(1e-3).minimize(cross_entropy)

correct_prediction = tf.equal(tf.argmax(y_conv, 1), tf.argmax(y_, 1))
accuracy = tf.reduce_mean(tf.cast(correct_prediction, tf.float32))

def test(sess):
    X = cifar.test.images.reshape(10, 1000, 32, 32, 3)
    Y = cifar.test.labels.reshape(10, 1000, 10)
    acc = np.mean([sess.run(accuracy, feed_dict={x: X[i], y_: Y[i],
                                                keep_prob: 1.0})
                  for i in range(10)])
    print "Accuracy: {:.4}%".format(acc * 100)

with tf.Session() as sess:
    sess.run(tf.global_variables_initializer())

    for i in range(STEPS):
        batch = cifar.train.next_batch(BATCH_SIZE)
        sess.run(train_step, feed_dict={x: batch[0], y_: batch[1],
                                        keep_prob: 0.5})

    test(sess)

```

This first attempt will achieve approximately 70% accuracy within a few minutes (using a batch size of 100, and depending naturally on hardware and configurations). Is this good? As of now, state-of-the-art deep learning methods achieve over 95% accuracy on this dataset,<sup>3</sup> but using much larger models and usually many, many hours of training.

---

<sup>3</sup> See [Who Is the Best in CIFAR-10?](#) for a list of methods and associated papers.

There are a few differences between this and the similar MNIST model presented earlier. First, the input consists of images of size  $32 \times 32 \times 3$ , the third dimension being the three color channels:

```
x = tf.placeholder(tf.float32, shape=[None, 32, 32, 3])
```

Similarly, after the two pooling operations, we are left this time with 64 feature maps of size  $8 \times 8$ :

```
conv2_flat = tf.reshape(conv2_pool, [-1, 8 * 8 * 64])
```

Finally, as a matter of convenience, we group the test procedure into a separate function called `test()`, and we do not print training accuracy values (which can be added back in using the same code as in the MNIST model).

Once we have a model with some acceptable baseline accuracy (whether derived from a simple MNIST model or from a state-of-the-art model for some other dataset), a common practice is to try to improve it by means of a sequence of adaptations and changes, until reaching what is necessary for our purposes.

In this case, leaving all the rest the same, we will add a third convolution layer with 128 feature maps and dropout. We will also reduce the number of units in the fully connected layer from 1,024 to 512:

```
x = tf.placeholder(tf.float32, shape=[None, 32, 32, 3])
y_ = tf.placeholder(tf.float32, shape=[None, 10])
keep_prob = tf.placeholder(tf.float32)

conv1 = conv_layer(x, shape=[5, 5, 3, 32])
conv1_pool = max_pool_2x2(conv1)

conv2 = conv_layer(conv1_pool, shape=[5, 5, 32, 64])
conv2_pool = max_pool_2x2(conv2)

conv3 = conv_layer(conv2_pool, shape=[5, 5, 64, 128])
conv3_pool = max_pool_2x2(conv3)
conv3_flat = tf.reshape(conv3_pool, [-1, 4 * 4 * 128])
conv3_drop = tf.nn.dropout(conv3_flat, keep_prob=keep_prob)

full_1 = tf.nn.relu(full_layer(conv3_drop, 512))
full1_drop = tf.nn.dropout(full_1, keep_prob=keep_prob)

y_conv = full_layer(full1_drop, 10)
```

This model will take slightly longer to run (but still way under an hour, even without sophisticated hardware) and achieve an accuracy of approximately 75%.

There is still a rather large gap between this and the best known methods. There are several independently applicable elements that can help close this gap:

### *Model size*

Most successful methods for this and similar datasets use much deeper networks with many more adjustable parameters.

### *Additional types of layers and methods*

Additional types of popular layers are often used together with the layers presented here, such as local response normalization.

### *Optimization tricks*

More about this later!

### *Domain knowledge*

Pre-processing utilizing domain knowledge often goes a long way. In this case that would be good old-fashioned image processing.

### *Data augmentation*

Adding training data based on the existing set can help. For instance, if an image of a dog is flipped horizontally, then it is clearly still an image of a dog (but what about a vertical flip?). Small shifts and rotations are also commonly used.

### *Reusing successful methods and architectures*

As in most engineering fields, starting from a time-proven method and adapting it to your needs is often the way to go. In the field of deep learning this is often done by fine-tuning pretrained models.

The final model we will present in this chapter is a smaller version of the type of model that actually produces great results for this dataset. This model is still compact and fast, and achieves approximately 83% accuracy after ~150 epochs:

```
C1, C2, C3 = 30, 50, 80
F1 = 500
```

```
conv1_1 = conv_layer(x, shape=[3, 3, 3, C1])
conv1_2 = conv_layer(conv1_1, shape=[3, 3, C1, C1])
conv1_3 = conv_layer(conv1_2, shape=[3, 3, C1, C1])
conv1_pool = max_pool_2x2(conv1_3)
conv1_drop = tf.nn.dropout(conv1_pool, keep_prob)

conv2_1 = conv_layer(conv1_drop, shape=[3, 3, C1, C2])
conv2_2 = conv_layer(conv2_1, shape=[3, 3, C2, C2])
conv2_3 = conv_layer(conv2_2, shape=[3, 3, C2, C2])
conv2_pool = max_pool_2x2(conv2_3)
conv2_drop = tf.nn.dropout(conv2_pool, keep_prob)

conv3_1 = conv_layer(conv2_drop, shape=[3, 3, C2, C3])
conv3_2 = conv_layer(conv3_1, shape=[3, 3, C3, C3])
conv3_3 = conv_layer(conv3_2, shape=[3, 3, C3, C3])
conv3_pool = tf.nn.max_pool(conv3_3, ksize=[1, 8, 8, 1], strides=[1, 8, 8, 1],
                             padding='SAME')
conv3_flat = tf.reshape(conv3_pool, [-1, C3])
```

```

conv3_drop = tf.nn.dropout(conv3_flat, keep_prob=keep_prob)

full1 = tf.nn.relu(full_layer(conv3_flat, F1))
full1_drop = tf.nn.dropout(full1, keep_prob=keep_prob)

y_conv = full_layer(full1_drop, 10)

```

This model consists of three blocks of convolutional layers, followed by the fully connected and output layers we have already seen a few times before. Each block of convolutional layers contains three consecutive convolutional layers, followed by a single pooling and dropout.

The constants C1, C2, and C3 control the number of feature maps in each layer of each of the convolutional blocks, and the constant F1 controls the number of units in the fully connected layer.

After the third block of convolutional layers, we use an 8×8 max pool layer:

```

conv3_pool = tf.nn.max_pool(conv3_3, ksize=[1, 8, 8, 1], strides=[1, 8, 8, 1],
                             padding='SAME')

```

Since at this point the feature maps are of size 8×8 (following the first two poolings that each reduced the 32×32 pictures by half on each axis), this globally pools each of the feature maps and keeps only the maximal value. The number of feature maps at the third block was set to 80, so at this point (following the max pooling) the representation is reduced to only 80 numbers. This keeps the overall size of the model small, as the number of parameters in the transition to the fully connected layer is kept down to 80×500.

## Summary

In this chapter we introduced convolutional neural networks and the various building blocks they are typically made of. Once you are able to get small models working properly, try running larger and deeper ones, following the same principles. While you can always have a peek in the latest literature and see what works, a lot can be learned from trial and error and figuring some of it out for yourself. In the next chapters, we will see how to work with text and sequence data and how to use TensorFlow abstractions to build CNN models with ease.

---

# Text I: Working with Text and Sequences, and TensorBoard Visualization

In this chapter we show how to work with sequences in TensorFlow, and in particular text. We begin by introducing recurrent neural networks (RNNs), a powerful class of deep learning algorithms particularly useful and popular in natural language processing (NLP). We show how to implement RNN models from scratch, introduce some important TensorFlow capabilities, and visualize the model with the interactive TensorBoard. We then explore how to use an RNN in a supervised text classification problem with word-embedding training. Finally, we show how to build a more advanced RNN model with long short-term memory (LSTM) networks and how to handle sequences of variable length.

## The Importance of Sequence Data

We saw in the previous chapter that using the spatial structure of images can lead to advanced models with excellent results. As discussed in that chapter, exploiting structure is the key to success. As we will see shortly, an immensely important and useful type of structure is the sequential structure. Thinking in terms of data science, this fundamental structure appears in many datasets, across all domains. In computer vision, video is a sequence of visual content evolving over time. In speech we have audio signals, in genomics gene sequences; we have longitudinal medical records in healthcare, financial data in the stock market, and so on (see [Figure 5-1](#)).

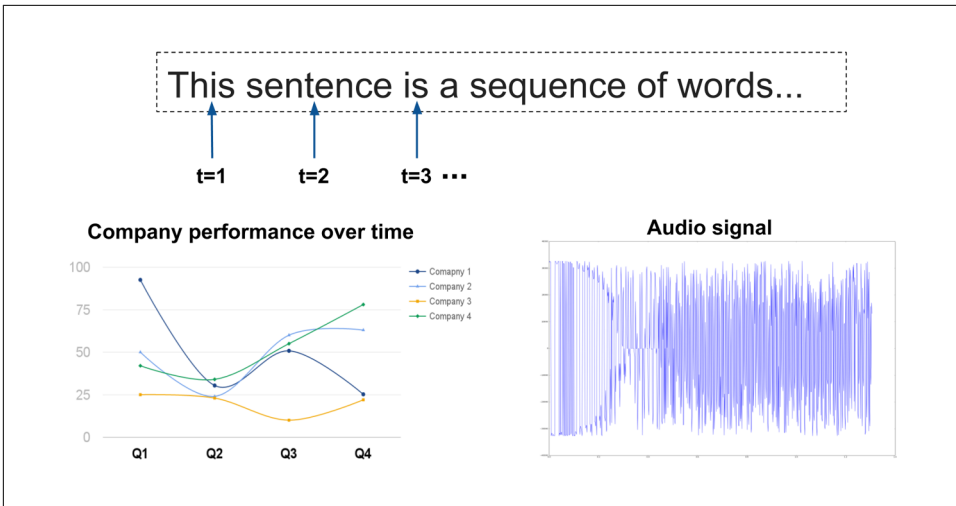

Figure 5-1. The ubiquity of sequence data.

A particularly important type of data with strong sequential structure is natural language—text data. Deep learning methods that exploit the sequential structure inherent in texts—characters, words, sentences, paragraphs, documents—are at the forefront of natural language understanding (NLU) systems, often leaving more traditional methods in the dust. There are a great many types of NLU tasks that are of interest to solve, ranging from document classification to building powerful language models, from answering questions automatically to generating human-level conversation agents. These tasks are fiendishly difficult, garnering the efforts and attention of the entire AI community in both academia and industry.

In this chapter, we focus on the basic building blocks and tasks, and show how to work with sequences—primarily of text—in TensorFlow. We take a detailed deep dive into the core elements of sequence models in TensorFlow, implementing some of them from scratch, to gain a thorough understanding. In the next chapter we show more advanced text modeling techniques with TensorFlow, and in [Chapter 7](#) we use abstraction libraries that offer simpler, high-level ways to implement our models.

We begin with the most important and popular class of deep learning models for sequences (in particular, text): recurrent neural networks.

## Introduction to Recurrent Neural Networks

Recurrent neural networks are a powerful and widely used class of neural network architectures for modeling sequence data. The basic idea behind RNN models is that each new element in the sequence contributes some new information, which updates the current state of the model.

In the previous chapter, which explored computer vision with CNN models, we discussed how those architectures are inspired by the current scientific perceptions of the way the human brain processes visual information. These scientific perceptions are often rather close to our commonplace intuition from our day-to-day lives about how we process sequential information.

When we receive new information, clearly our “history” and “memory” are not wiped out, but instead “updated.” When we read a sentence in some text, with each new word, our current state of information is updated, and it is dependent not only on the new observed word but on the words that preceded it.

A fundamental mathematical construct in statistics and probability, which is often used as a building block for modeling sequential patterns via machine learning is the Markov chain model. Figuratively speaking, we can view our data sequences as “chains,” with each node in the chain dependent in some way on the previous node, so that “history” is not erased but carried on.

RNN models are also based on this notion of chain structure, and vary in how exactly they maintain and update information. As their name implies, recurrent neural nets apply some form of “loop.” As seen in [Figure 5-2](#), at some point in time  $t$ , the network observes an input  $x_t$  (a word in a sentence) and updates its “state vector” to  $h_t$  from the previous vector  $h_{t-1}$ . When we process new input (the next word), it will be done in some manner that is dependent on  $h_t$  and thus on the history of the sequence (the previous words we’ve seen affect our understanding of the current word). As seen in the illustration, this recurrent structure can simply be viewed as one long unrolled chain, with each node in the chain performing the same kind of processing “step” based on the “message” it obtains from the output of the previous node. This, of course, is very related to the Markov chain models discussed previously and their hidden Markov model (HMM) extensions, which are not discussed in this book.

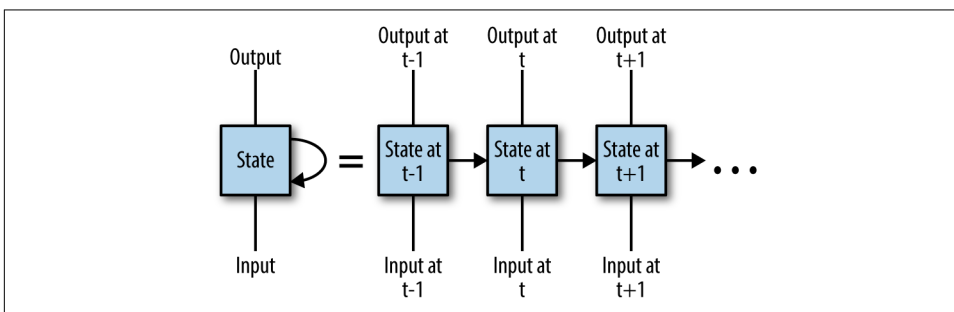

*Figure 5-2. Recurrent neural networks updating with new information received over time.*

## Vanilla RNN Implementation

In this section we implement a basic RNN from scratch, explore its inner workings, and gain insight into how TensorFlow can work with sequences. We introduce some powerful, fairly low-level tools that TensorFlow provides for working with sequence data, which you can use to implement your own systems.

In the next sections, we will show how to use higher-level TensorFlow RNN modules.

We begin with defining our basic model mathematically. This mainly consists of defining the recurrence structure—the RNN update step.

The update step for our simple vanilla RNN is

$$h_t = \tanh(W_x x_t + W_h h_{t-1} + b)$$

where  $W_h$ ,  $W_x$ , and  $b$  are weight and bias variables we learn,  $\tanh(\cdot)$  is the hyperbolic tangent function that has its range in  $[-1,1]$  and is strongly connected to the sigmoid function used in previous chapters, and  $x_t$  and  $h_t$  are the input and state vectors as defined previously. Finally, the hidden state vector is multiplied by another set of weights, yielding the outputs that appear in [Figure 5-2](#).

### MNIST images as sequences

To get a first taste of the power and general applicability of sequence models, in this section we implement our first RNN to solve the MNIST image classification task that you are by now familiar with. Later in this chapter we will focus on sequences of text, and see how neural sequence models can powerfully manipulate them and extract information to solve NLU tasks.

But, you may ask, what have images got to do with sequences?

As we saw in the previous chapter, the architecture of convolutional neural networks makes use of the spatial structure of images. While the structure of natural images is well suited for CNN models, it is revealing to look at the structure of images from different angles. In a trend in cutting-edge deep learning research, advanced models attempt to exploit various kinds of sequential structures in images, trying to capture in some sense the “generative process” that created each image. Intuitively, this all comes down to the notion that nearby areas in images are somehow related, and trying to model this structure.

Here, to introduce basic RNNs and how to work with sequences, we take a simple sequential view of images: we look at each image in our data as a sequence of rows (or columns). In our MNIST data, this just means that each 28×28-pixel image can be viewed as a sequence of length 28, each element in the sequence a vector of 28 pixels (see [Figure 5-3](#)). Then, the temporal dependencies in the RNN can be imaged as a



scanner head, scanning the image from top to bottom (rows) or left to right (columns).

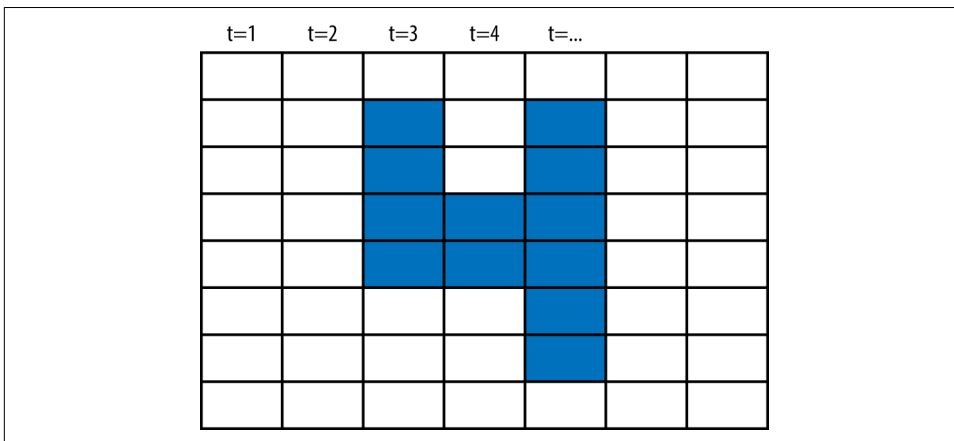

Figure 5-3. An image as a sequence of pixel columns.

We start by loading data, defining some parameters, and creating placeholders for our data:

```
import tensorflow as tf

# Import MNIST data
from tensorflow.examples.tutorials.mnist import input_data
mnist = input_data.read_data_sets("/tmp/data/", one_hot=True)

# Define some parameters
element_size = 28
time_steps = 28
num_classes = 10
batch_size = 128
hidden_layer_size = 128

# Where to save TensorBoard model summaries
LOG_DIR = "logs/RNN_with_summaries"

# Create placeholders for inputs, labels
_inputs = tf.placeholder(tf.float32, shape=[None, time_steps,
                                           element_size],
                        name='inputs')
y = tf.placeholder(tf.float32, shape=[None, num_classes],
                  name='labels')
```

`element_size` is the dimension of each vector in our sequence—in our case, a row/column of 28 pixels. `time_steps` is the number of such elements in a sequence.

As we saw in previous chapters, when we load data with the built-in MNIST data loader, it comes in unrolled form—a vector of 784 pixels. When we load batches of data during training (we'll get to that later in this section), we simply reshape each unrolled vector to `[batch_size, time_steps, element_size]`:

```
batch_x, batch_y = mnist.train.next_batch(batch_size)
# Reshape data to get 28 sequences of 28 pixels
batch_x = batch_x.reshape((batch_size, time_steps, element_size))
```

We set `hidden_layer_size` (arbitrarily to 128, controlling the size of the hidden RNN state vector discussed earlier.

`LOG_DIR` is the directory to which we save model summaries for TensorBoard visualization. You will learn what this means as we go.



### TensorBoard visualizations

In this chapter, we will also briefly introduce TensorBoard visualizations. TensorBoard allows you to monitor and explore the model structure, weights, and training process, and requires some very simple additions to the code. More details are provided throughout this chapter and further along in the book.

Finally, our input and label placeholders are created with the suitable dimensions.

### The RNN step

Let's implement the mathematical model for the RNN step.

We first create a function used for logging summaries, which we will use later in TensorBoard to visualize our model and training process (it is not important to understand its technicalities at this stage):

```
# This helper function, taken from the official TensorFlow documentation,
# simply adds some ops that take care of logging summaries
def variable_summaries(var):
    with tf.name_scope('summaries'):
        mean = tf.reduce_mean(var)
        tf.summary.scalar('mean', mean)
        with tf.name_scope('stddev'):
            stddev = tf.sqrt(tf.reduce_mean(tf.square(var - mean)))
        tf.summary.scalar('stddev', stddev)
        tf.summary.scalar('max', tf.reduce_max(var))
        tf.summary.scalar('min', tf.reduce_min(var))
        tf.summary.histogram('histogram', var)
```

Next, we create the weight and bias variables used in the RNN step:

```
# Weights and bias for input and hidden layer
with tf.name_scope('rnn_weights'):
```

```

with tf.name_scope("W_x"):
    Wx = tf.Variable(tf.zeros([element_size, hidden_layer_size]))
    variable_summaries(Wx)
with tf.name_scope("W_h"):
    Wh = tf.Variable(tf.zeros([hidden_layer_size, hidden_layer_size]))
    variable_summaries(Wh)
with tf.name_scope("Bias"):
    b_rnn = tf.Variable(tf.zeros([hidden_layer_size]))
    variable_summaries(b_rnn)

```

## Applying the RNN step with tf.scan()

We now create a function that implements the vanilla RNN step we saw in the previous section using the variables we created. It should by now be straightforward to understand the TensorFlow code used here:

```

def rnn_step(previous_hidden_state,x):

    current_hidden_state = tf.tanh(
        tf.matmul(previous_hidden_state, Wh) +
        tf.matmul(x, Wx) + b_rnn)

    return current_hidden_state

```

Next, we apply this function across all 28 time steps:

```

# Processing inputs to work with scan function
# Current input shape: (batch_size, time_steps, element_size)
processed_input = tf.transpose(_inputs, perm=[1, 0, 2])
# Current input shape now: (time_steps, batch_size, element_size)

initial_hidden = tf.zeros([batch_size,hidden_layer_size])
# Getting all state vectors across time
all_hidden_states = tf.scan(rnn_step,
                            processed_input,
                            initializer=initial_hidden,
                            name='states')

```

In this small code block, there are some important elements to understand. First, we reshape the inputs from `[batch_size, time_steps, element_size]` to `[time_steps, batch_size, element_size]`. The `perm` argument to `tf.transpose()` tells TensorFlow which axes we want to switch around. Now that the first axis in our input Tensor represents the time axis, we can iterate across all time steps by using the built-in `tf.scan()` function, which repeatedly applies a callable (function) to a sequence of elements in order, as explained in the following note.



## tf.scan()

This important function was added to TensorFlow to allow us to introduce loops into the computation graph, instead of just “unrolling” the loops explicitly by adding more and more replications of the same operations. More technically, it is a higher-order function very similar to the reduce operator, but it returns all intermediate accumulator values over time. There are several advantages to this approach, chief among them the ability to have a dynamic number of iterations rather than fixed, computational speeds and optimizations for graph construction.

To demonstrate the use of this function, consider the following simple example (which is separate from the overall RNN code in this section):

```
import numpy as np
import tensorflow as tf

elems = np.array(["T","e","n","s","o","r", " ", "F","l","o","w"])
scan_sum = tf.scan(lambda a, x: a + x, elems)

sess=tf.InteractiveSession()
sess.run(scan_sum)
```

Let’s see what we get:

```
array([b'T', b'Te', b'Ten', b'Tens', b'Tenso', b'Tensor', b'Tensor ',
       b'Tensor F', b'Tensor Fl', b'Tensor Flo', b'Tensor Flow'],
      dtype=object)
```

In this case, we use `tf.scan()` to sequentially concatenate characters to a string, in a manner analogous to the arithmetic cumulative sum.

## Sequential outputs

As we saw earlier, in an RNN we get a state vector for each time step, multiply it by some weights, and get an output vector—our new representation of the data. Let’s implement this:

```
# Weights for output layers
with tf.name_scope('linear_layer_weights') as scope:
    with tf.name_scope("W_linear"):
        wl = tf.Variable(tf.truncated_normal([hidden_layer_size,
                                              num_classes],
                                              mean=0, stddev=.01))

        variable_summaries(wl)
    with tf.name_scope("Bias_linear"):
        bl = tf.Variable(tf.truncated_normal([num_classes],
                                              mean=0, stddev=.01))

        variable_summaries(bl)
```

```

# Apply linear layer to state vector
def get_linear_layer(hidden_state):

    return tf.matmul(hidden_state, Wl) + bl

with tf.name_scope('linear_layer_weights') as scope:
    # Iterate across time, apply linear layer to all RNN outputs
    all_outputs = tf.map_fn(get_linear_layer, all_hidden_states)
    # Get last output
    output = all_outputs[-1]
    tf.summary.histogram('outputs', output)

```

Our input to the RNN is sequential, and so is our output. In this sequence classification example, we take the last state vector and pass it through a fully connected linear layer to extract an output vector (which will later be passed through a softmax activation function to generate predictions). This is common practice in basic sequence classification, where we assume that the last state vector has “accumulated” information representing the entire sequence.

To implement this, we first define the linear layer’s weights and bias term variables, and create a factory function for this layer. Then we apply this layer to all outputs with `tf.map_fn()`, which is pretty much the same as the typical map function that applies functions to sequences/iterables in an element-wise manner, in this case on each element in our sequence.

Finally, we extract the last output for each instance in the batch, with negative indexing (similarly to ordinary Python). We will see some more ways to do this later and investigate outputs and states in some more depth.

## RNN classification

We’re now ready to train a classifier, much in the same way we did in the previous chapters. We define the ops for loss function computation, optimization, and prediction, add some more summaries for TensorBoard, and merge all these summaries into one operation:

```

with tf.name_scope('cross_entropy'):
    cross_entropy = tf.reduce_mean(
        tf.nn.softmax_cross_entropy_with_logits(logits=output, labels=y))
    tf.summary.scalar('cross_entropy', cross_entropy)

with tf.name_scope('train'):
    # Using RMSPropOptimizer
    train_step = tf.train.RMSPropOptimizer(0.001, 0.9)\
        .minimize(cross_entropy)

with tf.name_scope('accuracy'):
    correct_prediction = tf.equal(
        tf.argmax(y,1), tf.argmax(output,1))

```

```

accuracy = (tf.reduce_mean(
    tf.cast(correct_prediction, tf.float32)))*100
tf.summary.scalar('accuracy', accuracy)

# Merge all the summaries
merged = tf.summary.merge_all()

```

By now you should be familiar with most of the components used for defining the loss function and optimization. Here, we used the RMSPropOptimizer, implementing a well-known and strong gradient descent algorithm, with some standard hyperparameters. Of course, we could have used any other optimizer (and do so throughout this book!).

We create a small test set with unseen MNIST images, and add some more technical ops and commands for logging summaries that we will use in TensorBoard.

Let's run the model and check out the results:

```

# Get a small test set
test_data = mnist.test.images[:batch_size].reshape((-1, time_steps,
                                                    element_size))
test_label = mnist.test.labels[:batch_size]

with tf.Session() as sess:
    # Write summaries to LOG_DIR -- used by TensorBoard
    train_writer = tf.summary.FileWriter(LOG_DIR + '/train',
                                        graph=tf.get_default_graph())
    test_writer = tf.summary.FileWriter(LOG_DIR + '/test',
                                       graph=tf.get_default_graph())

    sess.run(tf.global_variables_initializer())

    for i in range(10000):

        batch_x, batch_y = mnist.train.next_batch(batch_size)
        # Reshape data to get 28 sequences of 28 pixels
        batch_x = batch_x.reshape((batch_size, time_steps,
                                   element_size))
        summary,_ = sess.run([merged,train_step],
                             feed_dict={_inputs:batch_x, y:batch_y})
        # Add to summaries
        train_writer.add_summary(summary, i)

        if i % 1000 == 0:
            acc,loss, = sess.run([accuracy,cross_entropy],
                                feed_dict={_inputs: batch_x,
                                             y: batch_y})
            print ("Iter " + str(i) + ", Minibatch Loss= " + \
                  "{:.6f}".format(loss) + ", Training Accuracy= " + \
                  "{:.5f}".format(acc))

        if i % 10:
            # Calculate accuracy for 128 MNIST test images and

```

```

# add to summaries
summary, acc = sess.run([merged, accuracy],
                        feed_dict={_inputs: test_data,
                                   y: test_label})
test_writer.add_summary(summary, i)

test_acc = sess.run(accuracy, feed_dict={_inputs: test_data,
                                         y: test_label})

print ("Test Accuracy:", test_acc)

```

Finally, we print some training and testing accuracy results:

```

Iter 0, Minibatch Loss= 2.303386, Training Accuracy= 7.03125
Iter 1000, Minibatch Loss= 1.238117, Training Accuracy= 52.34375
Iter 2000, Minibatch Loss= 0.614925, Training Accuracy= 85.15625
Iter 3000, Minibatch Loss= 0.439684, Training Accuracy= 82.81250
Iter 4000, Minibatch Loss= 0.077756, Training Accuracy= 98.43750
Iter 5000, Minibatch Loss= 0.220726, Training Accuracy= 89.84375
Iter 6000, Minibatch Loss= 0.015013, Training Accuracy= 100.00000
Iter 7000, Minibatch Loss= 0.017689, Training Accuracy= 100.00000
Iter 8000, Minibatch Loss= 0.065443, Training Accuracy= 99.21875
Iter 9000, Minibatch Loss= 0.071438, Training Accuracy= 98.43750
Testing Accuracy: 97.6563

```

To summarize this section, we started off with the raw MNIST pixels and regarded them as sequential data—each column (or row) of 28 pixels as a time step. We then applied the vanilla RNN to extract outputs corresponding to each time-step and used the last output to perform classification of the entire sequence (image).

## Visualizing the model with TensorBoard

TensorBoard is an interactive browser-based tool that allows us to visualize the learning process, as well as explore our trained model.

To run TensorBoard, go to the command terminal and tell TensorBoard where the relevant summaries you logged are:

```
tensorboard --logdir=LOG_DIR
```

Here, *LOG\_DIR* should be replaced with your log directory. If you are on Windows and this is not working, make sure you are running the terminal from the same drive where the log data is, and add a name to the log directory as follows in order to bypass a bug in the way TensorBoard parses the path:

```
tensorboard --logdir=rnn_demo:LOG_DIR
```

TensorBoard allows us to assign names to individual log directories by putting a colon between the name and the path, which may be useful when working with multiple log directories. In such a case, we pass a comma-separated list of log directories as follows:

```
tensorboard --logdir=rnn_demo1:LOG_DIR1, rnn_demo2:LOG_DIR2
```

In our example (with one log directory), once you have run the `tensorboard` command, you should get something like the following, telling you where to navigate in your browser:

```
Starting TensorBoard b'39' on port 6006
(You can navigate to http://10.100.102.4:6006)
```

If the address does not work, go to `localhost:6006`, which should always work.

TensorBoard recursively walks the directory tree rooted at `LOG_DIR` looking for subdirectories that contain `tfevents` log data. If you run this example multiple times, make sure to either delete the `LOG_DIR` folder you created after each run, or write the logs to separate subdirectories within `LOG_DIR`, such as `LOG_DIR/run1/train`, `LOG_DIR/run2/train`, and so forth, to avoid issues with overwriting log files, which may lead to some “funky” plots.

Let’s take a look at some of the visualizations we can get. In the next section, we will explore interactive visualization of high-dimensional data with TensorBoard—for now, we focus on plotting training process summaries and trained weights.

First, in your browser, go to the Scalars tab. Here TensorBoard shows us summaries of all scalars, including not only training and testing accuracy, which are usually most interesting, but also some summary statistics we logged about variables (see [Figure 5-4](#)). Hovering over the plots, we can see some numerical figures.

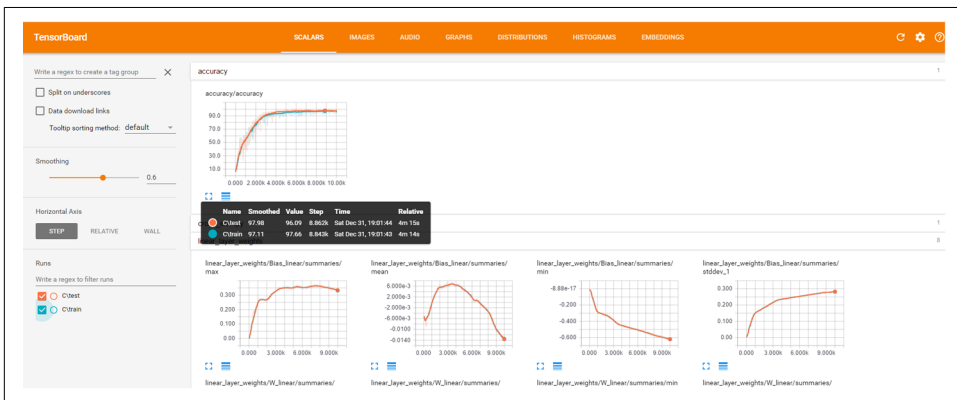

Figure 5-4. TensorBoard scalar summaries.

In the Graphs tab we can get an interactive visualization of our computation graph, from a high-level view down to the basic ops, by zooming in (see [Figure 5-5](#)).



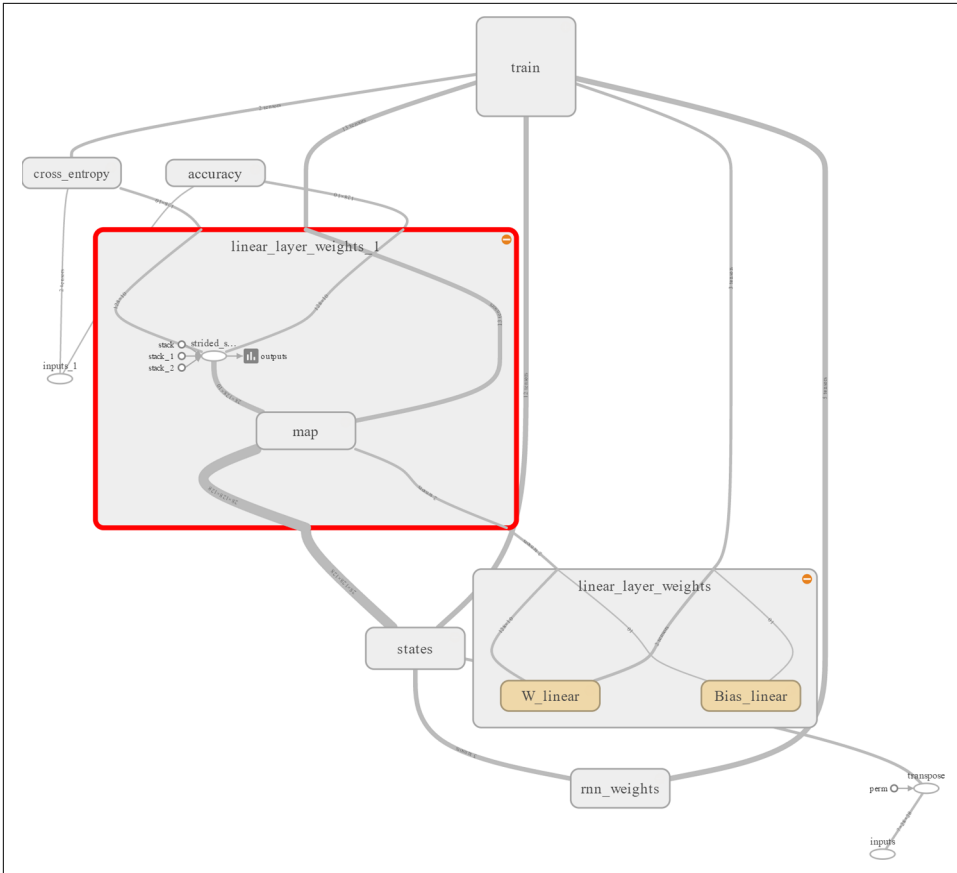

Figure 5-5. Zooming in on the computation graph.

Finally, in the Histograms tab we see histograms of our weights across the training process (see Figure 5-6). Of course, we had to explicitly add these histograms to our logging in order to view them, with `tf.summary.histogram()`.

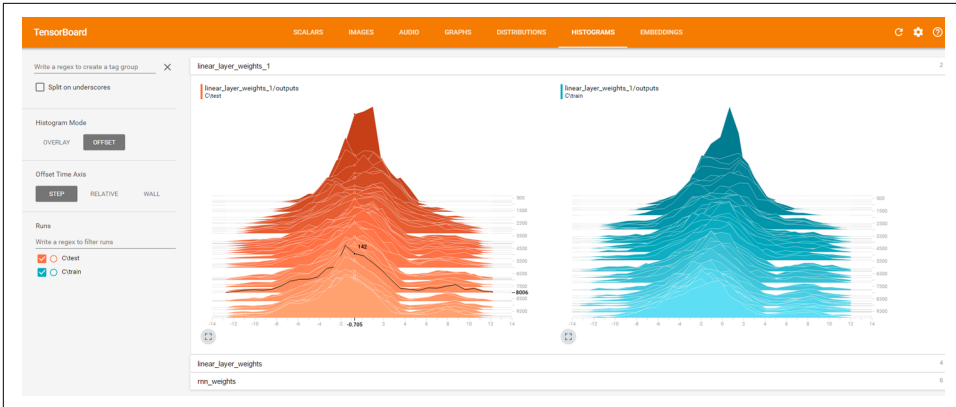

Figure 5-6. Histograms of weights throughout the learning process.

## TensorFlow Built-in RNN Functions

The preceding example taught us some of the fundamental and powerful ways we can work with sequences, by implementing our graph pretty much from scratch. In practice, it is of course a good idea to use built-in higher-level modules and functions. This not only makes the code shorter and easier to write, but exploits many low-level optimizations afforded by TensorFlow implementations.

In this section we first present a new, shorter version of the code in its entirety. Since most of the overall details have not changed, we focus on the main new elements, `tf.contrib.rnn.BasicRNNCell` and `tf.nn.dynamic_rnn()`:

```
import tensorflow as tf
from tensorflow.examples.tutorials.mnist import input_data
mnist = input_data.read_data_sets("/tmp/data/", one_hot=True)

element_size = 28;time_steps = 28;num_classes = 10
batch_size = 128;hidden_layer_size = 128

_inputs = tf.placeholder(tf.float32,shape=[None, time_steps,
                                         element_size],
                        name='inputs')
y = tf.placeholder(tf.float32, shape=[None, num_classes],name='inputs')

# TensorFlow built-in functions
rnn_cell = tf.contrib.rnn.BasicRNNCell(hidden_layer_size)
outputs, _ = tf.nn.dynamic_rnn(rnn_cell, _inputs, dtype=tf.float32)

Wl = tf.Variable(tf.truncated_normal([hidden_layer_size, num_classes],
                                     mean=0,stddev=.01))
bl = tf.Variable(tf.truncated_normal([num_classes],mean=0,stddev=.01))

def get_linear_layer(vector):
```

```

    return tf.matmul(vector, Wl) + bl

last_rnn_output = outputs[:, -1, :]
final_output = get_linear_layer(last_rnn_output)

softmax = tf.nn.softmax_cross_entropy_with_logits(logits=final_output,
                                                  labels=y)
cross_entropy = tf.reduce_mean(softmax)
train_step = tf.train.RMSPropOptimizer(0.001, 0.9).minimize(cross_entropy)

correct_prediction = tf.equal(tf.argmax(y,1), tf.argmax(final_output,1))
accuracy = (tf.reduce_mean(tf.cast(correct_prediction, tf.float32)))*100

sess=tf.InteractiveSession()
sess.run(tf.global_variables_initializer())

test_data = mnist.test.images[:batch_size].reshape((-1,
                                                    time_steps, element_size))
test_label = mnist.test.labels[:batch_size]

for i in range(3001):

    batch_x, batch_y = mnist.train.next_batch(batch_size)
    batch_x = batch_x.reshape((batch_size, time_steps, element_size))
    sess.run(train_step, feed_dict={_inputs:batch_x,
                                    y:batch_y})

    if i % 1000 == 0:
        acc = sess.run(accuracy, feed_dict={_inputs: batch_x,
                                            y: batch_y})
        loss = sess.run(cross_entropy, feed_dict={_inputs:batch_x,
                                                y:batch_y})

        print ("Iter " + str(i) + ", Minibatch Loss= " + \
              "{:.6f}".format(loss) + ", Training Accuracy= " + \
              "{:.5f}".format(acc))

print ("Testing Accuracy:",
      sess.run(accuracy, feed_dict={_inputs: test_data, y: test_label}))

```

### tf.contrib.rnn.BasicRNNCell and tf.nn.dynamic\_rnn()

TensorFlow’s RNN cells are abstractions that represent the basic operations each recurrent “cell” carries out (see [Figure 5-2](#) at the start of this chapter for an illustration), and its associated state. They are, in general terms, a “replacement” of the `rnn_step()` function and the associated variables it required. Of course, there are many variants and types of cells, each with many methods and properties. We will see some more advanced cells toward the end of this chapter and later in the book.

Once we have created the `rnn_cell`, we feed it into `tf.nn.dynamic_rnn()`. This function replaces `tf.scan()` in our vanilla implementation and creates an RNN specified by `rnn_cell`.

As of this writing, in early 2017, TensorFlow includes a static and a dynamic function for creating an RNN. What does this mean? The static version creates an unrolled graph (as in [Figure 5-2](#)) of fixed length. The dynamic version uses a `tf.While` loop to dynamically construct the graph at execution time, leading to faster graph creation, which can be significant. This dynamic construction can also be very useful in other ways, some of which we will touch on when we discuss variable-length sequences toward the end of this chapter.

Note that *contrib* refers to the fact that code in this library is contributed and still requires testing. We discuss the `contrib` library in much more detail in [Chapter 7](#). `BasicRNNCell` was moved to `contrib` in TensorFlow 1.0 as part of ongoing development. In version 1.2, many of the RNN functions and classes were moved back to the core namespace with aliases kept in `contrib` for backward compatibility, meaning that the preceding code works for all versions 1.X as of this writing.

## RNN for Text Sequences

We began this chapter by learning how to implement RNN models in TensorFlow. For ease of exposition, we showed how to implement and use an RNN for a sequence made of pixels in MNIST images. We next show how to use these sequence models on text sequences.

Text data has some properties distinctly different from image data, which we will discuss here and later in this book. These properties can make it somewhat difficult to handle text data at first, and text data always requires at least some basic pre-processing steps for us to be able to work with it. To introduce working with text in TensorFlow, we will thus focus on the core components and create a minimal, contrived text dataset that will let us get straight to the action. In [Chapter 7](#), we will apply RNN models to movie review sentiment classification.

Let's get started, presenting our example data and discussing some key properties of text datasets as we go.

### Text Sequences

In the MNIST RNN example we saw earlier, each sequence was of fixed size—the width (or height) of an image. Each element in the sequence was a dense vector of 28 pixels. In NLP tasks and datasets, we have a different kind of “picture.”

Our sequences could be of words forming a sentence, of sentences forming a paragraph, or even of characters forming words or paragraphs forming whole documents.

Consider the following sentence: “Our company provides smart agriculture solutions for farms, with advanced AI, deep-learning.” Say we obtain this sentence from an online news blog, and wish to process it as part of our machine learning system.

Each of the words in this sentence would be represented with an ID—an integer, commonly referred to as a token ID in NLP. So, the word “agriculture” could, for instance, be mapped to the integer 3452, the word “farm” to 12, “AI” to 150, and “deep-learning” to 0. This representation in terms of integer identifiers is very different from the vector of pixels in image data, in multiple ways. We will elaborate on this important point shortly when we discuss word embeddings, and in [Chapter 6](#).

To make things more concrete, let’s start by creating our simplified text data.

Our simulated data consists of two classes of very short “sentences,” one composed of odd digits and the other of even digits (with numbers written in English). We generate sentences built of words representing even and odd numbers. Our goal is to learn to classify each sentence as either odd or even in a supervised text-classification task.

Of course, we do not really need any machine learning for this simple task—we use this contrived example only for illustrative purposes.

First, we define some constants, which will be explained as we go:

```
import numpy as np
import tensorflow as tf

batch_size = 128;embedding_dimension = 64;num_classes = 2
hidden_layer_size = 32;times_steps = 6;element_size = 1
```

Next, we create sentences. We sample random digits and map them to the corresponding “words” (e.g., 1 is mapped to “One,” 7 to “Seven,” etc.).

Text sequences typically have variable lengths, which is of course the case for all real natural language data (such as in the sentences appearing on this page).

To make our simulated sentences have different lengths, we sample for each sentence a random length between 3 and 6 with `np.random.choice(range(3, 7))`—the lower bound is inclusive, and the upper bound is exclusive.

Now, to put all our input sentences in one tensor (per batch of data instances), we need them to somehow be of the same size—so we pad sentences with a length shorter than 6 with zeros (or *PAD* symbols) to make all sentences equally sized (artificially). This pre-processing step is known as *zero-padding*. The following code accomplishes all of this:

```

digit_to_word_map = {1:"One", 2:"Two", 3:"Three", 4:"Four", 5:"Five",
                    6:"Six", 7:"Seven", 8:"Eight", 9:"Nine"}
digit_to_word_map[0]="PAD"

even_sentences = []
odd_sentences = []
seqLens = []
for i in range(10000):
    rand_seq_len = np.random.choice(range(3,7))
    seqLens.append(rand_seq_len)
    rand_odd_ints = np.random.choice(range(1,10,2),
                                    rand_seq_len)
    rand_even_ints = np.random.choice(range(2,10,2),
                                      rand_seq_len)

    # Padding
    if rand_seq_len<6:
        rand_odd_ints = np.append(rand_odd_ints,
                                  [0]*(6-rand_seq_len))
        rand_even_ints = np.append(rand_even_ints,
                                    [0]*(6-rand_seq_len))

    even_sentences.append(" ".join([digit_to_word_map[r] for
                                    r in rand_odd_ints]))
    odd_sentences.append(" ".join([digit_to_word_map[r] for
                                   r in rand_even_ints]))

data = even_sentences+odd_sentences
# Same seq lengths for even, odd sentences
seqLens*=2

```

Let's take a look at our sentences, each padded to length 6:

```
even_sentences[0:6]
```

Out:

```

['Four Four Two Four Two PAD',
 'Eight Six Four PAD PAD PAD',
 'Eight Two Six Two PAD PAD',
 'Eight Four Four Eight PAD PAD',
 'Eight Eight Four PAD PAD PAD',
 'Two Two Eight Six Eight Four']

```

```
odd_sentences[0:6]
```

Out:

```

['One Seven Nine Three One PAD',
 'Three Nine One PAD PAD PAD',
 'Seven Five Three Three PAD PAD',
 'Five Five Three One PAD PAD',
 'Three Three Five PAD PAD PAD',
 'Nine Three Nine Five Five Three']

```

Notice that we add the *PAD* word (token) to our data and `digit_to_word_map` dictionary, and separately store even and odd sentences and their original lengths (before padding).

Let's take a look at the original sequence lengths for the sentences we printed:

```
seqLens[0:6]
```

```
Out:
```

```
[5, 3, 4, 4, 3, 6]
```

Why keep the original sentence lengths? By zero-padding, we solved one technical problem but created another: if we naively pass these padded sentences through our RNN model as they are, it will process useless *PAD* symbols. This would both harm model correctness by processing “noise” and increase computation time. We resolve this issue by first storing the original lengths in the `seqLens` array and then telling TensorFlow's `tf.nn.dynamic_rnn()` where each sentence ends.

In this chapter, our data is simulated—generated by us. In real applications, we would start off by getting a collection of documents (e.g., one-sentence tweets) and then mapping each word to an integer ID.

So, we now map words to indices—word *identifiers*—by simply creating a dictionary with words as keys and indices as values. We also create the inverse map. Note that there is no correspondence between the word IDs and the digits each word represents—the IDs carry no semantic meaning, just as in any NLP application with real data:

```
# Map from words to indices
word2index_map = {}
index=0
for sent in data:
    for word in sent.lower().split():
        if word not in word2index_map:
            word2index_map[word] = index
            index+=1
# Inverse map
index2word_map = {index: word for word, index in word2index_map.items()}
vocabulary_size = len(index2word_map)
```

This is a supervised classification task—we need an array of labels in the one-hot format, train and test sets, a function to generate batches of instances, and placeholders, as usual.

First, we create the labels and split the data into train and test sets:

```
labels = [1]*10000 + [0]*10000
for i in range(len(labels)):
    label = labels[i]
    one_hot_encoding = [0]*2
    one_hot_encoding[label] = 1
    labels[i] = one_hot_encoding

data_indices = list(range(len(data)))
np.random.shuffle(data_indices)
data = np.array(data)[data_indices]

labels = np.array(labels)[data_indices]
seqLens = np.array(seqLens)[data_indices]
train_x = data[:10000]
train_y = labels[:10000]
train_seqLens = seqLens[:10000]

test_x = data[10000:]
test_y = labels[10000:]
test_seqLens = seqLens[10000:]
```

Next, we create a function that generates batches of sentences. Each sentence in a batch is simply a list of integer IDs corresponding to words:

```
def get_sentence_batch(batch_size, data_x,
                      data_y, data_seqLens):
    instance_indices = list(range(len(data_x)))
    np.random.shuffle(instance_indices)
    batch = instance_indices[:batch_size]
    x = [[word2index_map[word] for word in data_x[i].lower().split()]
          for i in batch]
    y = [data_y[i] for i in batch]
    seqLens = [data_seqLens[i] for i in batch]
    return x, y, seqLens
```

Finally, we create placeholders for data:

```
_inputs = tf.placeholder(tf.int32, shape=[batch_size, times_steps])
_labels = tf.placeholder(tf.float32, shape=[batch_size, num_classes])

# seqLens for dynamic calculation
_seqLens = tf.placeholder(tf.int32, shape=[batch_size])
```

Note that we have created a placeholder for the original sequence lengths. We will see how to make use of these in our RNN shortly.

## Supervised Word Embeddings

Our text data is now encoded as lists of word IDs—each sentence is a sequence of integers corresponding to words. This type of *atomic* representation, where each



word is represented with an ID, is not scalable for training deep learning models with large vocabularies that occur in real problems. We could end up with millions of such word IDs, each encoded in one-hot (binary) categorical form, leading to great data sparsity and computational issues. We will discuss this in more depth in [Chapter 6](#).

A powerful approach to work around this issue is to use word embeddings. The embedding is, in a nutshell, simply a mapping from high-dimensional one-hot vectors encoding words to lower-dimensional dense vectors. So, for example, if our vocabulary has size 100,000, each word in one-hot representation would be of the same size. The corresponding word vector—or *word embedding*—would be of size 300, say. The high-dimensional one-hot vectors are thus “embedded” into a continuous vector space with a much lower dimensionality.

In [Chapter 6](#) we dive deeper into word embeddings, exploring a popular method to train them in an “unsupervised” manner known as word2vec.

Here, our end goal is to solve a text classification problem, and we will train word vectors in a supervised framework, tuning the embedded word vectors to solve the downstream classification task.

It is helpful to think of word embeddings as basic hash tables or lookup tables, mapping words to their dense vector values. These vectors are optimized as part of the training process. Previously, we gave each word an integer index, and sentences are then represented as sequences of these indices. Now, to obtain a word’s vector, we use the built-in `tf.nn.embedding_lookup()` function, which efficiently retrieves the vectors for each word in a given sequence of word indices:

```
with tf.name_scope("embeddings"):
    embeddings = tf.Variable(
        tf.random_uniform([vocabulary_size,
                           embedding_dimension],
                           -1.0, 1.0), name='embedding')
    embed = tf.nn.embedding_lookup(embeddings, _inputs)
```

We will see examples of and visualizations of our vector representations of words shortly.

## LSTM and Using Sequence Length

In the introductory RNN example with which we began, we implemented and used the basic vanilla RNN model. In practice, we often use slightly more advanced RNN models, which differ mainly by how they update their hidden state and propagate information through time. A very popular recurrent network is the long short-term memory (LSTM) network. It differs from vanilla RNN by having some special *memory mechanisms* that enable the recurrent cells to better store information for long periods of time, thus allowing them to capture long-term dependencies better than plain RNN.

There is nothing mysterious about these memory mechanisms; they simply consist of some more parameters added to each recurrent cell, enabling the RNN to overcome optimization issues and propagate information. These trainable parameters act as filters that select what information is worth “remembering” and passing on, and what is worth “forgetting.” They are trained in exactly the same way as any other parameter in a network, with gradient-descent algorithms and backpropagation. We don’t go into the more technical mathematical formulations here, but there are plenty of great resources out there delving into the details.

We create an LSTM cell with `tf.contrib.rnn.BasicLSTMCell()` and feed it to `tf.nn.dynamic_rnn()`, just as we did at the start of this chapter. We also give `dynamic_rnn()` the length of each sequence in a batch of examples, using the `_seq_lens` placeholder we created earlier. TensorFlow uses this to stop all RNN steps beyond the last real sequence element. It also returns all output vectors over time (in the `outputs` tensor), which are all zero-padded beyond the true end of the sequence. So, for example, if the length of our original sequence is 5 and we zero-pad it to a sequence of length 15, the output for all time steps beyond 5 will be zero:

```
with tf.variable_scope("lstm"):

    lstm_cell = tf.contrib.rnn.BasicLSTMCell(hidden_layer_size,
                                             forget_bias=1.0)

    outputs, states = tf.nn.dynamic_rnn(lstm_cell, embed,
                                       sequence_length = _seq_lens,
                                       dtype=tf.float32)

    weights = {
        'linear_layer': tf.Variable(tf.truncated_normal([hidden_layer_size,
                                                       num_classes],
                                                       mean=0, stddev=.01))
    }
    biases = {
        'linear_layer': tf.Variable(tf.truncated_normal([num_classes],
                                                       mean=0, stddev=.01))
    }

    # Extract the last relevant output and use in a linear layer
    final_output = tf.matmul(states[1],
                              weights["linear_layer"]) + biases["linear_layer"]
    softmax = tf.nn.softmax_cross_entropy_with_logits(logits = final_output,
                                                       labels = _labels)
    cross_entropy = tf.reduce_mean(softmax)
```

We take the last valid output vector—in this case conveniently available for us in the `states` tensor returned by `dynamic_rnn()`—and pass it through a linear layer (and the softmax function), using it as our final prediction. We will explore the concepts of

last relevant output and zero-padding further in the next section, when we look at some outputs generated by `dynamic_rnn()` for our example sentences.

## Training Embeddings and the LSTM Classifier

We have all the pieces in the puzzle. Let's put them together, and complete an end-to-end training of both word vectors and a classification model:

```
train_step = tf.train.RMSPropOptimizer(0.001, 0.9).minimize(cross_entropy)
correct_prediction = tf.equal(tf.argmax(_labels,1),
                              tf.argmax(final_output,1))
accuracy = (tf.reduce_mean(tf.cast(correct_prediction,
                                  tf.float32)))*100

with tf.Session() as sess:
    sess.run(tf.global_variables_initializer())

    for step in range(1000):
        x_batch, y_batch, seqlen_batch = get_sentence_batch(batch_size,
                                                            train_x, train_y,
                                                            train_seqLens)
        sess.run(train_step, feed_dict={_inputs:x_batch, _labels:y_batch,
                                         _seqLens:seqlen_batch})

        if step % 100 == 0:
            acc = sess.run(accuracy, feed_dict={_inputs:x_batch,
                                                _labels:y_batch,
                                                _seqLens:seqlen_batch})
            print("Accuracy at %d: %.5f" % (step, acc))

    for test_batch in range(5):
        x_test, y_test, seqlen_test = get_sentence_batch(batch_size,
                                                         test_x, test_y,
                                                         test_seqLens)
        batch_pred, batch_acc = sess.run([tf.argmax(final_output,1),
                                          accuracy],
                                         feed_dict={_inputs:x_test,
                                                     _labels:y_test,
                                                     _seqLens:seqlen_test})
        print("Test batch accuracy %d: %.5f" % (test_batch, batch_acc))

    output_example = sess.run([outputs], feed_dict={_inputs:x_test,
                                                    _labels:y_test,
                                                    _seqLens:seqlen_test})
    states_example = sess.run([states[1]], feed_dict={_inputs:x_test,
                                                    _labels:y_test,
                                                    _seqLens:seqlen_test})
```

As we can see, this is a pretty simple toy text classification problem:

```

Accuracy at 0: 32.81250
Accuracy at 100: 100.00000
Accuracy at 200: 100.00000
Accuracy at 300: 100.00000
Accuracy at 400: 100.00000
Accuracy at 500: 100.00000
Accuracy at 600: 100.00000
Accuracy at 700: 100.00000
Accuracy at 800: 100.00000
Accuracy at 900: 100.00000
Test batch accuracy 0: 100.00000
Test batch accuracy 1: 100.00000
Test batch accuracy 2: 100.00000
Test batch accuracy 3: 100.00000
Test batch accuracy 4: 100.00000

```

We've also computed an example batch of outputs generated by `dynamic_rnn()`, to further illustrate the concepts of zero-padding and last relevant outputs discussed in the previous section.

Let's take a look at one example of these outputs, for a sentence that was zero-padded (in your random batch of data you may see different output, of course—look for a sentence whose `seqlen` was lower than the maximal 6):

```

seqlen_test[1]

Out:
4

output_example[0][1].shape

Out:
(6, 32)

```

This output has, as expected, six time steps, each a vector of size 32. Let's take a glimpse at its values (printing only the first few dimensions to avoid clutter):

```

output_example[0][1][:6,0:3]

Out:
array([[ -0.44493711, -0.51363373, -0.49310589],
       [ -0.72036862, -0.68590945, -0.73340571],
       [ -0.83176643, -0.78206956, -0.87831545],
       [ -0.87982416, -0.82784462, -0.91132098],
       [  0.          ,  0.          ,  0.          ],
       [  0.          ,  0.          ,  0.          ]], dtype=float32)

```

We see that for this sentence, whose original length was 4, the last two time steps have zero vectors due to padding.

Finally, we look at the states vector returned by `dynamic_rnn()`:

```
states_example[0][1][0:3]
```

Out:

```
array([-0.87982416, -0.82784462, -0.91132098], dtype=float32)
```

We can see that it conveniently stores for us the last relevant output vector—its values match the last relevant output vector before zero-padding.

At this point, you may be wondering how to access and manipulate the word vectors and explore the trained representation. We show how to do so, including interactive embedding visualization, in the next chapter.

## Stacking multiple LSTMs

Earlier, we focused on a one-layer LSTM network for ease of exposition. Adding more layers is straightforward, using the `MultiRNNCell()` wrapper that combines multiple RNN cells into one multilayer cell.

Say, for example, we wanted to stack two LSTM layers in the preceding example. We can do this as follows:

```
num_lstm_layers = 2
with tf.variable_scope("lstm"):

    lstm_cell = tf.contrib.rnn.BasicLSTMCell(hidden_layer_size,
                                             forget_bias=1.0)
    cell = tf.contrib.rnn.MultiRNNCell(cells=[lstm_cell]*num_lstm_layers,
                                         state_is_tuple=True)
    outputs, states = tf.nn.dynamic_rnn(cell, embed,
                                       sequence_length = _seqLens,
                                       dtype=tf.float32)
```

We first define an LSTM cell as before, and then feed it into the `tf.contrib.rnn.MultiRNNCell()` wrapper.

Now our network has two layers of LSTM, causing some shape issues when trying to extract the final state vectors. To get the final state of the second layer, we simply adapt our indexing a bit:

```
# Extract the final state and use in a linear layer
final_output = tf.matmul(states[num_lstm_layers-1][1],
                          weights["linear_layer"]) + biases["linear_layer"]
```

## Summary

In this chapter we introduced sequence models in TensorFlow. We saw how to implement a basic RNN model from scratch by using `tf.scan()` and built-in modules, as well as more advanced LSTM networks, for both text and image data. Finally, we trained an end-to-end text classification RNN with word embeddings, and showed

how to handle sequences of variable length. In the next chapter, we dive deeper into word embeddings and word2vec. In [Chapter 7](#), we will see some cool abstraction layers over TensorFlow, and how they can be used to train advanced text classification RNN models with considerably less effort.

---

# Text II: Word Vectors, Advanced RNN, and Embedding Visualization

In this chapter, we go deeper into important topics discussed in [Chapter 5](#) regarding working with text sequences. We first show how to train word vectors by using an unsupervised method known as *word2vec*, and how to visualize embeddings interactively with TensorBoard. We then use pretrained word vectors, trained on massive amounts of public data, in a supervised text-classification task, and also introduce more-advanced RNN components that are frequently used in state-of-the-art systems.

## Introduction to Word Embeddings

In [Chapter 5](#) we introduced RNN models and working with text sequences in TensorFlow. As part of the supervised model training, we also trained word vectors—mapping from word IDs to lower-dimensional continuous vectors. The reasoning for this was to enable a scalable representation that can be fed into an RNN layer. But there are deeper reasons for the use of word vectors, which we discuss next.

Consider the sentence appearing in [Figure 6-1](#): “Our company provides smart agriculture solutions for farms, with advanced AI, deep-learning.” This sentence may be taken from, say, a tweet promoting a company. As data scientists or engineers, we now may wish to process it as part of an advanced machine intelligence system, that sifts through tweets and automatically detects informative content (e.g., public sentiment).

In one of the major traditional natural language processing (NLP) approaches to text processing, each of the words in this sentence would be represented with N ID—say, an integer. So, as we posited in the previous chapter, the word “agriculture” might be

mapped to the integer 3452, the word “farm” to 12, “AI” to 150, and “deep-learning” to 0.

While this representation has led to excellent results in practice in some basic NLP tasks and is still often used in many cases (such as in bag-of-words text classification), it has some major inherent problems. First, by using this type of atomic representation, we lose all meaning encoded within the word, and crucially, we thus lose information on the semantic proximity between words. In our example, we of course know that “agriculture” and “farm” are strongly related, and so are “AI” and “deep-learning,” while deep learning and farms don’t usually have much to do with one another. This is not reflected by their arbitrary integer IDs.

Another important issue with this way of looking at data stems from the size of typical vocabularies, which can easily reach huge numbers. This means that naively, we could need to keep millions of such word identifiers, leading to great data sparsity and in turn, making learning harder and more expensive.

With images, such as in the MNIST data we used in the first section of [Chapter 5](#), this is not quite the case. While images can be high-dimensional, their natural representation in terms of pixel values already encodes some semantic meaning, and this representation is dense. In practice, RNN models like the one we saw in [Chapter 5](#) require dense vector representations to work well.

We would like, therefore, to use dense vector representations of words, which carry semantic meaning. But how do we obtain them?

In [Chapter 5](#) we trained supervised word vectors to solve a specific task, using labeled data. But it is often expensive for individuals and organizations to obtain labeled data, in terms of the resources, time, and effort involved in manually tagging texts or somehow acquiring enough labeled instances. Obtaining huge amounts of unlabeled data, however, is often a much less daunting endeavor. We thus would like a way to use this data to train word representations, in an unsupervised fashion.

There are actually many ways to do unsupervised training of word embeddings, including both more traditional approaches to NLP that can still work very well and newer methods, many of which use neural networks. Whether old or new, these all rely at their core on the *distributional hypothesis*, which is most easily explained by a well-known quote by linguist John Firth: “You shall know a word by the company it keeps.” In other words, words that tend to appear in similar contexts tend to have similar semantic meanings.

In this book, we focus on powerful word embedding methods based on neural networks. In [Chapter 5](#) we saw how to train them as part of a downstream text-classification task. We now show how to train word vectors in an unsupervised manner, and then how to use pretrained vectors that were trained using huge amounts of text from the web.



## Word2vec

Word2vec is a very well-known unsupervised word embedding approach. It is actually more like a family of algorithms, all based in some way on exploiting the context in which words appear to learn their representation (in the spirit of the distributional hypothesis). We focus on the most popular word2vec implementation, which trains a model that, given an input word, predicts the word's context by using something known as *skip-grams*. This is actually rather simple, as the following example will demonstrate.

Consider, again, our example sentence: “Our company provides smart agriculture solutions for farms, with advanced AI, deep-learning.” We define (for simplicity) the context of a word as its immediate neighbors (“the company it keeps”)—i.e., the word to its left and the word to its right. So, the context of “company” is [our, provides], the context of “AI” is [advanced, deep-learning], and so on (see [Figure 6-1](#)).

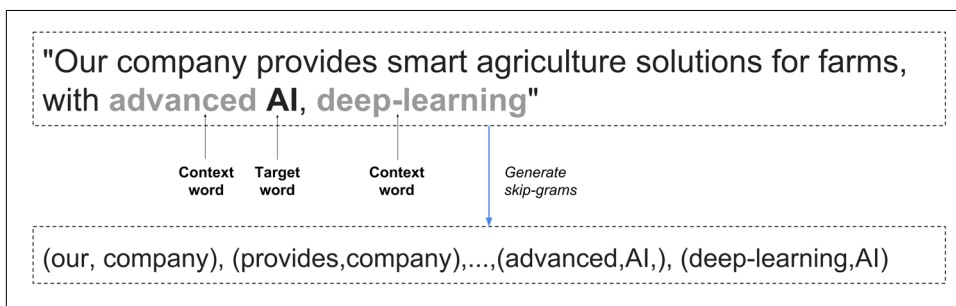

Figure 6-1. Generating skip-grams from text.

In the skip-gram word2vec model, we train a model to predict context based on an input word. All that means in this case is that we generate training instance and label pairs such as (our, company), (provides, company), (advanced, AI), (deep-learning, AI), etc.

In addition to these pairs we extract from the data, we also sample “fake” pairs—that is, for a given input word (such as “AI”), we also sample random noise words as context (such as “monkeys”), in a process known as *negative sampling*. We use the true pairs combined with noise pairs to build our training instances and labels, which we use to train a binary classifier that learns to distinguish between them. The trainable parameters in this classifier are the vector representations—word embeddings. We tune these vectors to yield a classifier able to tell the difference between true contexts of a word and randomly sampled ones, in a binary classification setting.

TensorFlow enables many ways to implement the word2vec model, with increasing levels of sophistication and optimization, using multithreading and higher-level

abstractions for optimized and shorter code. We present here a fundamental approach, which will introduce you to the core ideas and operations.

Let's dive straight into implementing the core ideas in TensorFlow code.

## Skip-Grams

We begin by preparing our data and extracting skip-grams. As in [Chapter 5](#), our data comprises two classes of very short “sentences,” one composed of odd digits and the other of even digits (with numbers written in English). We make sentences equally sized here, for simplicity, but this doesn't really matter for word2vec training. Let's start by setting some parameters and creating sentences:

```
import os
import math
import numpy as np
import tensorflow as tf
from tensorflow.contrib.tensorboard.plugins import projector

batch_size=64
embedding_dimension = 5
negative_samples =8
LOG_DIR = "logs/word2vec_intro"

digit_to_word_map = {1:"One", 2:"Two", 3:"Three", 4:"Four", 5:"Five",
                    6:"Six", 7:"Seven", 8:"Eight", 9:"Nine"}
sentences = []

# Create two kinds of sentences - sequences of odd and even digits
for i in range(10000):
    rand_odd_ints = np.random.choice(range(1,10,2),3)
    sentences.append(" ".join([digit_to_word_map[r] for r in rand_odd_ints]))
    rand_even_ints = np.random.choice(range(2,10,2),3)
    sentences.append(" ".join([digit_to_word_map[r] for r in rand_even_ints]))
```

Let's take a look at our sentences:

```
sentences[0:10]
```

Out:

```
['Seven One Five',
 'Four Four Four',
 'Five One Nine',
 'Eight Two Eight',
 'One Nine Three',
 'Two Six Eight',
 'Nine Seven Seven',
 'Six Eight Six',
 'One Five Five',
 'Four Six Two']
```

Next, as in [Chapter 5](#), we map words to indices by creating a dictionary with words as keys and indices as values, and create the inverse map:

```
# Map words to indices
word2index_map = {}
index=0
for sent in sentences:
    for word in sent.lower().split():
        if word not in word2index_map:
            word2index_map[word] = index
            index+=1
index2word_map = {index: word for word, index in word2index_map.items()}
vocabulary_size = len(index2word_map)
```

To prepare the data for word2vec, let's create skip-grams:

```
# Generate skip-gram pairs
skip_gram_pairs = []
for sent in sentences:
    tokenized_sent = sent.lower().split()
    for i in range(1, len(tokenized_sent)-1) :
        word_context_pair = [[word2index_map[tokenized_sent[i-1]],
                               word2index_map[tokenized_sent[i+1]]],
                              word2index_map[tokenized_sent[i]]]
        skip_gram_pairs.append([word_context_pair[1],
                                word_context_pair[0][0]])
        skip_gram_pairs.append([word_context_pair[1],
                                word_context_pair[0][1]])

def get_skipgram_batch(batch_size):
    instance_indices = list(range(len(skip_gram_pairs)))
    np.random.shuffle(instance_indices)
    batch = instance_indices[:batch_size]
    x = [skip_gram_pairs[i][0] for i in batch]
    y = [[skip_gram_pairs[i][1]] for i in batch]
    return x,y
```

Each skip-gram pair is composed of target and context word indices (given by the `word2index_map` dictionary, and not in correspondence to the actual digit each word represents). Let's take a look:

```
skip_gram_pairs[0:10]
```

```
Out:
[[1, 0],
 [1, 2],
 [3, 3],
 [3, 3],
 [1, 2],
 [1, 4],
 [6, 5],
 [6, 5],
```

```
[4, 1],  
[4, 7]]
```

We can generate batches of sequences of word indices, and check out the original sentences with the inverse dictionary we created earlier:

```
# Batch example  
x_batch, y_batch = get_skipgram_batch(8)  
x_batch  
y_batch  
[index2word_map[word] for word in x_batch]  
[index2word_map[word[0]] for word in y_batch]  
  
x_batch  
  
Out:  
[6, 2, 1, 1, 3, 0, 7, 2]  
  
y_batch  
  
Out:  
[[5], [0], [4], [0], [5], [4], [1], [7]]  
  
[index2word_map[word] for word in x_batch]  
  
Out:  
['two', 'five', 'one', 'one', 'four', 'seven', 'three', 'five']  
  
[index2word_map[word[0]] for word in y_batch]  
  
Out:  
['eight', 'seven', 'nine', 'seven', 'eight',  
 'nine', 'one', 'three']
```

Finally, we create our input and label placeholders:

```
# Input data, labels  
train_inputs = tf.placeholder(tf.int32, shape=[batch_size])  
train_labels = tf.placeholder(tf.int32, shape=[batch_size, 1])
```

## Embeddings in TensorFlow

In [Chapter 5](#), we used the built-in `tf.nn.embedding_lookup()` function as part of our supervised RNN. The same functionality is used here. Here too, word embeddings can be viewed as lookup tables that map words to vector values, which are optimized as part of the training process to minimize a loss function. As we shall see in the next section, unlike in [Chapter 5](#), here we use a loss function accounting for the unsupervised nature of the task, but the embedding lookup, which efficiently retrieves the vectors for each word in a given sequence of word indices, remains the same:

```

with tf.name_scope("embeddings"):
    embeddings = tf.Variable(
        tf.random_uniform([vocabulary_size, embedding_dimension],
                           -1.0, 1.0), name='embedding')
    # This is essentially a lookup table
    embed = tf.nn.embedding_lookup(embeddings, train_inputs)

```

## The Noise-Contrastive Estimation (NCE) Loss Function

In our introduction to skip-grams, we mentioned we create two types of context–target pairs of words: real ones that appear in the text, and “fake” noisy pairs that are generated by inserting random context words. Our goal is to learn to distinguish between the two, helping us learn a good word representation. We could draw random noisy context pairs ourselves, but luckily TensorFlow comes with a useful loss function designed especially for our task. `tf.nn.nce_loss()` automatically draws negative (“noise”) samples when we evaluate the loss (run it in a session):

```

# Create variables for the NCE loss
nce_weights = tf.Variable(
    tf.truncated_normal([vocabulary_size, embedding_dimension],
                        stddev=1.0 / math.sqrt(embedding_dimension)))
nce_biases = tf.Variable(tf.zeros([vocabulary_size]))

loss = tf.reduce_mean(
    tf.nn.nce_loss(weights = nce_weights, biases = nce_biases, inputs = embed,
                  labels = train_labels, num_sampled = negative_samples, num_classes =
                  vocabulary_size))

```

We don’t go into the mathematical details of this loss function, but it is sufficient to think of it as a sort of efficient approximation to the ordinary softmax function used in classification tasks, as introduced in previous chapters. We tune our embedding vectors to optimize this loss function. For more details about it, see the official TensorFlow [documentation](#) and references within.

We’re now ready to train. In addition to obtaining our word embeddings in TensorFlow, we next introduce two useful capabilities: adjustment of the optimization learning rate, and interactive visualization of embeddings.

## Learning Rate Decay

As discussed in previous chapters, gradient-descent optimization adjusts weights by making small steps in the direction that minimizes our loss function. The `learning_rate` hyperparameter controls just how aggressive these steps are. During gradient-descent training of a model, it is common practice to gradually make these steps smaller and smaller, so that we allow our optimization process to “settle down” as it approaches good points in the parameter space. This small addition to our train-

ing process can actually often lead to significant boosts in performance, and is a good practice to keep in mind in general.

`tf.train.exponential_decay()` applies exponential decay to the learning rate, with the exact form of decay controlled by a few hyperparameters, as seen in the following code (for exact details, see the official TensorFlow documentation at <http://bit.ly/2tluxP1>). Here, just as an example, we decay every 1,000 steps, and the decayed learning rate follows a staircase function—a piecewise constant function that resembles a staircase, as its name implies:

```
# Learning rate decay
global_step = tf.Variable(0, trainable=False)
learningRate = tf.train.exponential_decay(learning_rate=0.1,
                                          global_step= global_step,
                                          decay_steps=1000,
                                          decay_rate= 0.95,
                                          staircase=True)

train_step = tf.train.GradientDescentOptimizer(learningRate).minimize(loss)
```

## Training and Visualizing with TensorBoard

We train our graph within a session as usual, adding some lines of code enabling cool interactive visualization in TensorBoard, a new tool for visualizing embeddings of high-dimensional data—typically images or word vectors—introduced for TensorFlow in late 2016.

First, we create a TSV (tab-separated values) metadata file. This file connects embedding vectors with associated labels or images we may have for them. In our case, each embedding vector has a label that is just the word it stands for.

We then point TensorBoard to our embedding variables (in this case, only one), and link them to the metadata file.

Finally, after completing optimization but before closing the session, we normalize the word embedding vectors to unit length, a standard post-processing step:

```
# Merge all summary ops
merged = tf.summary.merge_all()

with tf.Session() as sess:
    train_writer = tf.summary.FileWriter(LOG_DIR,
                                         graph=tf.get_default_graph())
    saver = tf.train.Saver()

    with open(os.path.join(LOG_DIR, 'metadata.tsv'), "w") as metadata:
        metadata.write('Name\tClass\n')
        for k,v in index2word_map.items():
            metadata.write('%s\t%d\n' % (v, k))

    config = projector.ProjectorConfig()
```

```

embedding = config.embeddings.add()
embedding.tensor_name = embeddings.name
# Link embedding to its metadata file
embedding.metadata_path = os.path.join(LOG_DIR, 'metadata.tsv')
projector.visualize_embeddings(train_writer, config)

tf.global_variables_initializer().run()

for step in range(1000):
    x_batch, y_batch = get_skipgram_batch(batch_size)
    summary, _ = sess.run([merged, train_step],
                          feed_dict={train_inputs:x_batch,
                                      train_labels:y_batch})
    train_writer.add_summary(summary, step)

    if step % 100 == 0:
        saver.save(sess, os.path.join(LOG_DIR, "w2v_model.ckpt"), step)
        loss_value = sess.run(loss,
                              feed_dict={train_inputs:x_batch,
                                          train_labels:y_batch})
        print("Loss at %d: %.5f" % (step, loss_value))

# Normalize embeddings before using
norm = tf.sqrt(tf.reduce_sum(tf.square(embeddings), 1, keep_dims=True))
normalized_embeddings = embeddings / norm
normalized_embeddings_matrix = sess.run(normalized_embeddings)

```

## Checking Out Our Embeddings

Let's take a quick look at the word vectors we got. We select one word (*one*) and sort all the other word vectors by how close they are to it, in descending order:

```

ref_word = normalized_embeddings_matrix[word2index_map["one"]]

cosine_dists = np.dot(normalized_embeddings_matrix, ref_word)
ff = np.argsort(cosine_dists)[::-1][1:10]
for f in ff:
    print(index2word_map[f])
    print(cosine_dists[f])

```

Now let's take a look at the word distances from the *one* vector:

```

Out:
seven
0.946973
three
0.938362
nine
0.755187
five
0.701269
eight
-0.0702622

```

two  
-0.101749  
six  
-0.120306  
four  
-0.159601

We see that the word vectors representing odd numbers are similar (in terms of the dot product) to *one*, while those representing even numbers are not similar to it (and have a negative dot product with the *one* vector). We learned embedded vectors that allow us to distinguish between even and odd numbers—their respective vectors are far apart, and thus capture the context in which each word (odd or even digit) appeared.

Now, in TensorBoard, go to the Embeddings tab. This is a three-dimensional interactive visualization panel, where we can move around the space of our embedded vectors and explore different “angles,” zoom in, and more (see Figures 6-2 and 6-3). This enables us to understand our data and interpret the model in a visually comfortable manner. We can see, for instance, that the odd and even numbers occupy different areas in feature space.

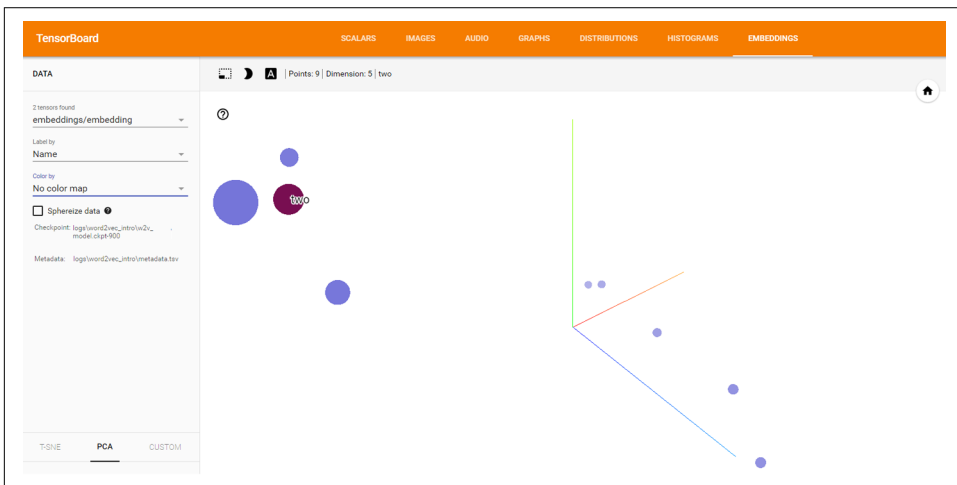

Figure 6-2. Interactive visualization of word embeddings.



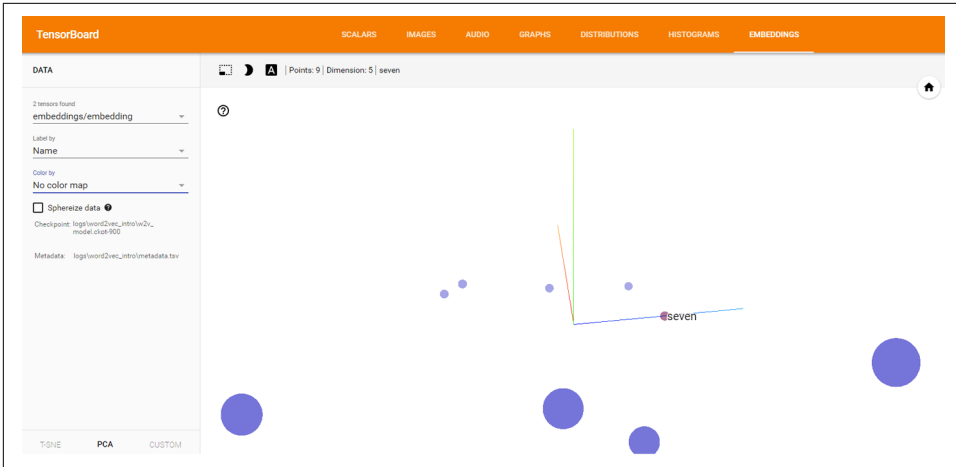

Figure 6-3. We can explore our word vectors from different angles (especially useful in high-dimensional problems with large vocabularies).

Of course, this type of visualization really shines when we have a great number of embedded vectors, such as in real text classification tasks with larger vocabularies, as we will see in [Chapter 7](#), for example, or in the Embedding Projector [TensorFlow demo](#). Here, we just give you a taste of how to interactively explore your data and deep learning models.

## Pretrained Embeddings, Advanced RNN

As we discussed earlier, word embeddings are a powerful component in deep learning models for text. A popular approach seen in many applications is to first train word vectors with methods such as word2vec on massive amounts of (unlabeled) text, and then use these vectors in a downstream task such as supervised document classification.

In the previous section, we trained unsupervised word vectors from scratch. This approach typically requires very large corpora, such as Wikipedia entries or web pages. In practice, we often use pretrained word embeddings, trained on such huge corpora and available online, in much the same manner as the pretrained models presented in previous chapters.

In this section, we show how to use pretrained word embeddings in TensorFlow in a simplified text-classification task. To make things more interesting, we also take this opportunity to introduce some more useful and powerful components that are frequently used in modern deep learning applications for natural language understanding: the bidirectional RNN layers and the gated recurrent unit (GRU) cell.

We will expand and adapt our text-classification example from [Chapter 5](#), focusing only on the parts that have changed.

## Pretrained Word Embeddings

Here, we show how to take word vectors trained based on web data and incorporate them into a (contrived) text-classification task. The embedding method is known as *GloVe*, and while we don't go into the details here, the overall idea is similar to that of *word2vec*—learning representations of words by the context in which they appear. Information on the method and its authors, and the pretrained vectors, is available on the project's [website](#).

We download the Common Crawl vectors (840B tokens), and proceed to our example.

We first set the path to the downloaded word vectors and some other parameters, as in [Chapter 5](#):

```
import zipfile
import numpy as np
import tensorflow as tf

path_to_glove = "path/to/glove/file"
PRE_TRAINED = True
GLOVE_SIZE = 300
batch_size = 128
embedding_dimension = 64
num_classes = 2
hidden_layer_size = 32
times_steps = 6
```

We then create the contrived, simple simulated data, also as in [Chapter 5](#) (see details there):

```
digit_to_word_map = {1:"One", 2:"Two", 3:"Three", 4:"Four", 5:"Five",
                    6:"Six", 7:"Seven", 8:"Eight", 9:"Nine"}
digit_to_word_map[0]="PAD_TOKEN"
even_sentences = []
odd_sentences = []
seq_lens = []
for i in range(10000):
    rand_seq_len = np.random.choice(range(3,7))
    seq_lens.append(rand_seq_len)
    rand_odd_ints = np.random.choice(range(1,10,2),
                                     rand_seq_len)
    rand_even_ints = np.random.choice(range(2,10,2),
                                      rand_seq_len)

    if rand_seq_len<6:
        rand_odd_ints = np.append(rand_odd_ints,
                                  [0]*(6-rand_seq_len))
        rand_even_ints = np.append(rand_even_ints,
```

```

        [0]*(6-rand_seq_len))

    even_sentences.append(" ".join([digit_to_word_map[r] for
                                     r in rand_odd_ints]))
    odd_sentences.append(" ".join([digit_to_word_map[r] for
                                    r in rand_even_ints]))
data = even_sentences+odd_sentences
# Same seq lengths for even, odd sentences
seq_lens*=2
labels = [1]*10000 + [0]*10000
for i in range(len(labels)):
    label = labels[i]
    one_hot_encoding = [0]*2
    one_hot_encoding[label] = 1
    labels[i] = one_hot_encoding

```

Next, we create the word index map:

```

word2index_map = {}
index=0
for sent in data:
    for word in sent.split():
        if word not in word2index_map:
            word2index_map[word] = index
            index+=1

index2word_map = {index: word for word, index in word2index_map.items()}

vocabulary_size = len(index2word_map)

```

Let's refresh our memory of its content—just a map from word to an (arbitrary) index:

```

word2index_map

Out:
{'Eight': 7,
 'Five': 1,
 'Four': 6,
 'Nine': 3,
 'One': 5,
 'PAD_TOKEN': 2,
 'Seven': 4,
 'Six': 9,
 'Three': 0,
 'Two': 8}

```

Now, we are ready to get word vectors. There are 2.2 million words in the vocabulary of the pretrained GloVe embeddings we downloaded, and in our toy example we have only 9. So, we take the GloVe vectors only for words that appear in our own tiny vocabulary:

```

def get_glove(path_to_glove,word2index_map):

    embedding_weights = {}
    count_all_words = 0
    with zipfile.ZipFile(path_to_glove) as z:
        with z.open("glove.840B.300d.txt") as f:
            for line in f:
                vals = line.split()
                word = str(vals[0].decode("utf-8"))
                if word in word2index_map:
                    print(word)
                    count_all_words+=1
                    coefs = np.asarray(vals[1:], dtype='float32')
                    coefs/=np.linalg.norm(coefs)
                    embedding_weights[word] = coefs
                if count_all_words==vocabulary_size -1:
                    break
    return embedding_weights
word2embedding_dict = get_glove(path_to_glove,word2index_map)

```

We go over the GloVe file line by line, take the word vectors we need, and normalize them. Once we have extracted the nine words we need, we stop the process and exit the loop. The output of our function is a dictionary, mapping from each word to its vector.

The next step is to place these vectors in a matrix, which is the required format for TensorFlow. In this matrix, each row index should correspond to the word index:

```

embedding_matrix = np.zeros((vocabulary_size ,GLOVE_SIZE))

for word,index in word2index_map.items():
    if not word == "PAD_TOKEN":
        word_embedding = word2embedding_dict[word]
        embedding_matrix[index,:] = word_embedding

```

Note that for the PAD\_TOKEN word, we set the corresponding vector to 0. As we saw in [Chapter 5](#), we ignore padded tokens in our call to `dynamic_rnn()` by telling it the original sequence length.

We now create our training and test data:

```

data_indices = list(range(len(data)))
np.random.shuffle(data_indices)
data = np.array(data)[data_indices]
labels = np.array(labels)[data_indices]
seqLens = np.array(seqLens)[data_indices]
train_x = data[:10000]
train_y = labels[:10000]
train_seqLens = seqLens[:10000]

test_x = data[10000:]
test_y = labels[10000:]

```

```

test_seqLens = seqLens[10000:]

def get_sentence_batch(batch_size,data_x,
                      data_y,data_seqLens):
    instance_indices = list(range(len(data_x)))
    np.random.shuffle(instance_indices)
    batch = instance_indices[:batch_size]
    x = [[word2index_map[word] for word in data_x[i].split()]
          for i in batch]
    y = [data_y[i] for i in batch]
    seqLens = [data_seqLens[i] for i in batch]
    return x,y,seqLens

```

And we create our input placeholders:

```

_inputs = tf.placeholder(tf.int32, shape=[batch_size,times_steps])
embedding_placeholder = tf.placeholder(tf.float32, [vocabulary_size,
                                                  GLOVE_SIZE])

_labels = tf.placeholder(tf.float32, shape=[batch_size, num_classes])
_seqLens = tf.placeholder(tf.int32, shape=[batch_size])

```

Note that we created an `embedding_placeholder`, to which we feed the word vectors:

```

if PRE_TRAINED:

    embeddings = tf.Variable(tf.constant(0.0, shape=[vocabulary_size,
                                                  GLOVE_SIZE]),
                             trainable=True)
    # If using pretrained embeddings, assign them to the embeddings variable
    embedding_init = embeddings.assign(embedding_placeholder)
    embed = tf.nn.embedding_lookup(embeddings, _inputs)

else:
    embeddings = tf.Variable(
        tf.random_uniform([vocabulary_size,
                           embedding_dimension],
                           -1.0, 1.0))
    embed = tf.nn.embedding_lookup(embeddings, _inputs)

```

Our embeddings are initialized with the content of `embedding_placeholder`, using the `assign()` function to assign initial values to the `embeddings` variable. We set `trainable=True` to tell TensorFlow we want to update the values of the word vectors, by optimizing them for the task at hand. However, it is often useful to set `trainable=False` and not update these values; for example, when we do not have much labeled data or have reason to believe the word vectors are already “good” at capturing the patterns we are after.

There is one more step missing to fully incorporate the word vectors into the training—feeding `embedding_placeholder` with `embedding_matrix`. We will get to that soon,

but for now we continue the graph building and introduce bidirectional RNN layers and GRU cells.

## Bidirectional RNN and GRU Cells

Bidirectional RNN layers are a simple extension of the RNN layers we saw in [Chapter 5](#). All they consist of, in their basic form, is two ordinary RNN layers: one layer that reads the sequence from left to right, and another that reads from right to left.

Each yields a hidden representation, the left-to-right vector  $\vec{h}$ , and the right-to-left vector  $\overleftarrow{h}$ . These are then concatenated into one vector. The major advantage of this representation is its ability to capture the context of words from both directions, which enables richer understanding of natural language and the underlying semantics in text. In practice, in complex tasks, it often leads to improved accuracy. For example, in part-of-speech (POS) tagging, we want to output a predicted tag for each word in a sentence (such as “noun,” “adjective,” etc.). In order to predict a POS tag for a given word, it is useful to have information on its surrounding words, from both directions.

Gated recurrent unit (GRU) cells are a simplification of sorts of LSTM cells. They also have a memory mechanism, but with considerably fewer parameters than LSTM. They are often used when there is less available data, and are faster to compute. We do not go into the mathematical details here, as they are not important for our purposes; there are many good online resources explaining GRU and how it is different from LSTM.

TensorFlow comes equipped with `tf.nn.bidirectional_dynamic_rnn()`, which is an extension of `dynamic_rnn()` for bidirectional layers. It takes `cell_fw` and `cell_bw` RNN cells, which are the left-to-right and right-to-left vectors, respectively. Here we use `GRUCell()` for our forward and backward representations and add dropout for regularization, using the built-in `DropoutWrapper()`:

```
with tf.name_scope("biGRU"):
    with tf.variable_scope('forward'):
        gru_fw_cell = tf.contrib.rnn.GRUCell(hidden_layer_size)
        gru_fw_cell = tf.contrib.rnn.DropoutWrapper(gru_fw_cell)

    with tf.variable_scope('backward'):
        gru_bw_cell = tf.contrib.rnn.GRUCell(hidden_layer_size)
        gru_bw_cell = tf.contrib.rnn.DropoutWrapper(gru_bw_cell)

    outputs, states = tf.nn.bidirectional_dynamic_rnn(cell_fw=gru_fw_cell,
                                                    cell_bw=gru_bw_cell,
                                                    inputs=embed,
                                                    sequence_length=
                                                        _seqLens,
                                                    dtype=tf.float32,
```

```

scope="BiGRU")
states = tf.concat(values=states, axis=1)

```

We concatenate the forward and backward state vectors by using `tf.concat()` along the suitable axis, and then add a linear layer followed by softmax as in [Chapter 5](#):

```

weights = {
    'linear_layer': tf.Variable(tf.truncated_normal([2*hidden_layer_size,
                                                    num_classes],
                                                    mean=0, stddev=.01))
}
biases = {
    'linear_layer': tf.Variable(tf.truncated_normal([num_classes],
                                                    mean=0, stddev=.01))
}

# extract the final state and use in a linear layer
final_output = tf.matmul(states,
                          weights["linear_layer"]) + biases["linear_layer"]

softmax = tf.nn.softmax_cross_entropy_with_logits(logits=final_output,
                                                  labels=_labels)
cross_entropy = tf.reduce_mean(softmax)

train_step = tf.train.RMSPropOptimizer(0.001, 0.9).minimize(cross_entropy)
correct_prediction = tf.equal(tf.argmax(_labels,1),
                              tf.argmax(final_output,1))
accuracy = (tf.reduce_mean(tf.cast(correct_prediction,
                                  tf.float32)))*100

```

We are now ready to train. We initialize the `embedding_placeholder` by feeding it our `embedding_matrix`. It's important to note that we do so after calling `tf.global_variables_initializer()`—doing this in the reverse order would over-run the pre-trained vectors with a default initializer:

```

with tf.Session() as sess:
    sess.run(tf.global_variables_initializer())
    sess.run(embedding_init, feed_dict=
              {embedding_placeholder: embedding_matrix})
    for step in range(1000):
        x_batch, y_batch, seqlen_batch = get_sentence_batch(batch_size,
                                                            train_x, train_y,
                                                            train_seqLens)
        sess.run(train_step, feed_dict={_inputs:x_batch, _labels:y_batch,
                                         _seqLens:seqlen_batch})

    if step % 100 == 0:
        acc = sess.run(accuracy, feed_dict={_inputs:x_batch,
                                           _labels:y_batch,
                                           _seqLens:seqlen_batch})
        print("Accuracy at %d: %.5f" % (step, acc))

```

```

for test_batch in range(5):
    x_test, y_test, seqlen_test = get_sentence_batch(batch_size,
                                                    test_x, test_y,
                                                    test_seqLens)

    batch_pred, batch_acc = sess.run([tf.argmax(final_output, 1),
                                      accuracy],
                                     feed_dict={_inputs: x_test,
                                                _labels: y_test,
                                                _seqLens: seqlen_test})

    print("Test batch accuracy %d: %.5f" % (test_batch, batch_acc))
    print("Test batch accuracy %d: %.5f" % (test_batch, batch_acc))

```

## Summary

In this chapter, we extended our knowledge regarding working with text sequences, adding some important tools to our TensorFlow toolbox. We saw a basic implementation of word2vec, learning the core concepts and ideas, and used TensorBoard for 3D interactive visualization of embeddings. We then incorporated publicly available GloVe word vectors, and RNN components that allow for richer and more efficient models. In the next chapter, we will see how to use abstraction libraries, including for classification tasks on real text data with LSTM networks.



---

# TensorFlow Abstractions and Simplifications

The aim of this chapter is to get you familiarized with important practical extensions to TensorFlow. We start by describing what abstractions are and why they are useful to us, followed by a brief review of some of the popular TensorFlow abstraction libraries. We then go into two of these libraries in more depth, demonstrating some of their core functionalities along with some examples.

## Chapter Overview

As most readers probably know, the term *abstraction* in the context of programming refers to a layer of code “on top” of existing code that performs purpose-driven generalizations of the original code. Abstractions are formed by grouping and wrapping pieces of code that are related to some higher-order functionality in a way that conveniently reframes them together. The result is simplified code that is easier to write, read, and debug, and generally easier and faster to work with. In many cases TensorFlow abstractions not only make the code cleaner, but can also drastically reduce code length and as a result significantly cut development time.

To get us going, let’s illustrate this basic notion in the context of TensorFlow, and take another look at some code for building a CNN like we did in [Chapter 4](#):

```
def weight_variable(shape):
    initial = tf.truncated_normal(shape, stddev=0.1)
    return tf.Variable(initial)

def bias_variable(shape):
    initial = tf.constant(0.1, shape=shape)
    return tf.Variable(initial)
```

```

def conv2d(x, W):
    return tf.nn.conv2d(x, W, strides=[1, 1, 1, 1],
                       padding='SAME')

def conv_layer(input, shape):
    W = weight_variable(shape)
    b = bias_variable([shape[3]])
    h = tf.nn.relu(conv2d(input, W) + b)
    hp = max_pool_2x2(h)
    return hp

def max_pool_2x2(x):
    return tf.nn.max_pool(x, ksize=[1, 2, 2, 1],
                          strides=[1, 2, 2, 1], padding='SAME')

x = tf.placeholder(tf.float32, shape=[None, 784])
x_image = tf.reshape(x, [-1, 28, 28, 1])

h1 = conv_layer(x_image, shape=[5, 5, 1, 32])
h2 = conv_layer(h1, shape=[5, 5, 32, 64])
h3 = conv_layer(h2, shape=[5, 5, 64, 32])

```

In native TensorFlow, in order to create a convolutional layer, we have to define and initialize its weights and biases according to the shapes of the input and the desired output, apply the convolution operation with defined strides and padding, and finally add the activation function operation. It's easy to either accidentally forget one of these fundamental components or get it wrong. Also, repeating this process multiple times can be somewhat laborious and feels as if it could be done more efficiently.

In the preceding code example we created our own little abstraction by using functions that eliminate some of the redundancies in this process. Let's compare the readability of that code with another version of it that does exactly the same, but without using any of the functions:

```

x = tf.placeholder(tf.float32, shape=[None, 784])
x_image = tf.reshape(x, [-1, 28, 28, 1])

W1 = tf.truncated_normal([5, 5, 1, 32], stddev=0.1)
b1 = tf.constant(0.1, shape=[32])
h1 = tf.nn.relu(tf.nn.conv2d(x_image, W1,
                             strides=[1, 1, 1, 1], padding='SAME') + b1)
hp1 = tf.nn.max_pool(h1, ksize=[1, 2, 2, 1],
                     strides=[1, 2, 2, 1], padding='SAME')
W2 = tf.truncated_normal([5, 5, 32, 64], stddev=0.1)
b2 = tf.constant(0.1, shape=[64])
h2 = tf.nn.relu(tf.nn.conv2d(hp1, W2,
                             strides=[1, 1, 1, 1], padding='SAME') + b2)
hp2 = tf.nn.max_pool(h2, ksize=[1, 2, 2, 1],
                     strides=[1, 2, 2, 1], padding='SAME')
W3 = tf.truncated_normal([5, 5, 64, 32], stddev=0.1)

```

```

b3 = tf.constant(0.1, shape=[32])
h3 = h1 = tf.nn.relu(tf.nn.conv2d(hp2, W3,
                                strides=[1, 1, 1, 1], padding='SAME') + b3)
hp3 = tf.nn.max_pool(h3, ksize=[1, 2, 2, 1],
                    strides=[1, 2, 2, 1], padding='SAME')

```

Even with just three layers, the resulting code looks pretty messy and confusing. Clearly, as we progress to larger and more advanced networks, code such as this would be hard to manage and pass around.

Beyond the more typical medium-sized batching of code, long and complex code is often “wrapped up” for us in abstraction libraries. This is particularly effective in relatively simple models where very little customization is ever required. As a preview to what will follow in the next section, you can already see how in `contrib.learn`, one of the abstractions available for TensorFlow, the core of defining and training a linear regression model similar to the one at the end of [Chapter 3](#) could be done in just two lines:

```

regressor = learn.LinearRegressor(feature_columns=feature_columns,
                                optimizer=optimizer)
regressor.fit(X, Y, steps=200, batch_size=506)

```

## High-Level Survey

More than a few great TensorFlow open source extensions are available at the time of writing this book. Among the popular ones are:

- `tf.contrib.learn`
- TFLearn
- TF-Slim
- Keras

While TFLearn needs to be installed, `contrib.learn` and TF-Slim (now `tf.contrib.slim`) are merged with TensorFlow and therefore require no installation. In 2017 Keras gained official Google support, and it has also been moved into `tf.contrib` as of version 1.1 (`tf.contrib.keras`). The name *contrib* refers to the fact that code in this library is “contributed” and still requires testing to see if it receives broad acceptance. Therefore, it could still change, and is yet to be part of the core TensorFlow.

`contrib.learn` started as an independent simplified interface for TensorFlow and was initially called *Scikit Flow*, with the intention of making the creation of complex networks with TensorFlow more accessible for those who are transitioning from the `scikit-learn` world of “one-liner” machine learning. As is often the case, it was later merged to TensorFlow and is now regarded as its *Learn module*, with extensive documentation and examples that are available on the official TensorFlow website.

Like other libraries, the main goal of `contrib.learn` is to make it easy to configure, train, and evaluate our learning models. For very simple models, you can use out-of-the-box implementations to train with just a few lines of code. Another great advantage of `contrib.learn`, as we will see shortly, is functionality with which data features can be handled very conveniently.

While `contrib.learn` is more transparent and low-level, the other three extensions are a bit cleaner and more abstract, and each has its own specialties and little advantages that might come in handy depending on the needs of the user.

TFLearn and Keras are full of functionality and have many of the elements needed for various types of state-of-the-art modeling. Unlike all the other libraries, which were created to communicate solely with TensorFlow, Keras supports both TensorFlow and Theano (a popular library for deep learning).

TF-Slim was created mainly for designing complex convolutional nets with ease and has a wide variety of pretrained models available, relieving us from the expensive process of having to train them ourselves.

These libraries are very dynamic and are constantly changing, with the developers adding new models and functionalities, and occasionally modifying their syntax.



### Theano

*Theano* is a Python library that allows you to manipulate symbolic mathematical expressions that involve tensor arrays in an efficient way, and as such it can serve as a deep learning framework, competing with TensorFlow. Theano has been around longer, and therefore is a bit more mature than TensorFlow, which is still changing and evolving but is rapidly becoming the leader of the pack (it is widely considered by many to already be the leading library, with many advantages over other frameworks).

In the following sections we demonstrate how to use these extensions, alongside some examples. We begin by focusing on `contrib.learn`, demonstrating how easily it lets us train and run simple regression and classification models. Next we introduce TFLearn and revisit the more advanced models introduced in the previous chapters—CNN and RNN. We then give a short introduction to autoencoders and demonstrate how to create one with Keras. Finally, we close this chapter with brief coverage of TF-Slim and show how to classify images using a loaded pretrained state-of-the-art CNN model.

# contrib.learn

Using `contrib.learn` doesn't require any installation since it's been merged with TensorFlow:

```
import tensorflow as tf
from tensorflow.contrib import learn
```

We start with `contrib.learn`'s out-of-the-box *estimators* (a fancy name for models), which we can train in a quick and efficient manner. These predefined estimators include simple linear and logistic regression models, a simple linear classifier, and a basic deep neural network. [Table 7-1](#) lists some of the popular estimators we can use.

Table 7-1. Popular built-in `contrib.learn` estimators

Estimator	Description
<code>LinearRegressor()</code>	Linear regression model to predict label value given observation of feature values.
<code>LogisticRegressor()</code>	Logistic regression estimator for binary classification.
<code>LinearClassifier()</code>	Linear model to classify instances into one of multiple possible classes. When the number of possible classes is 2, this is binary classification.
<code>DNNRegressor()</code>	A regressor for TensorFlow deep neural network (DNN) models.
<code>DNNClassifier()</code>	A classifier for TensorFlow DNN models.

Of course, we would also like to use more-advanced and customized models, and for that `contrib.learn` lets us conveniently wrap our own homemade estimators, a feature that will be covered as we go along. Once we have an estimator ready for deployment, whether it was made for us or we made it ourselves, the steps are pretty much the same:

1. We *instantiate* the estimator class to create our model:

```
model = learn.<some_Estimator>()
```

2. Then we *fit* it using our training data:

```
model.fit()
```

3. We *evaluate* the model to see how well it does on some given dataset:

```
model.evaluate()
```

4. Finally, we use our fitted model to *predict* outcomes, usually for new data:

```
model.predict()
```

These four fundamental stages are also found in other extensions.

`contrib` offers many other functionalities and features; in particular, `contrib.learn` has a very neat way to treat our input data, which will be the focus of the next subsection, where we discuss linear models.

## Linear Regression

We start our `contrib.learn` engagement with one of its strongest features: linear models. We say that a model is *linear* whenever it is defined by a function of a weighted sum of the features, or more formally  $f(w_1x_1 + w_2x_2 + \dots + w_nx_n)$ , where  $f$  could be any sort of function, like the identity function (as in linear regression) or a logistic function (as in logistic regression). Although limited in their expressive power, linear models have lots of advantages, such as clear interpretability, optimization speed, and simplicity.

In [Chapter 3](#) we created our own linear regression model using native TensorFlow by first creating a graph with placeholders for the input and target data, Variables for the set of parameters, a loss function, and an optimizer. After the model was defined, we ran the session and obtained results.

In the following section we first repeat this full process, and then show how drastically easier it is to do with `contrib.learn`. For this example we use the Boston Housing dataset, available to download using the [sklearn library](#). The Boston Housing dataset is a relatively small dataset (506 samples), containing information concerning housing in the area of Boston, Massachusetts. There are 13 predictors in this dataset:

1. CRIM: per capita crime rate by town
2. ZN: proportion of residential land zoned for lots over 25,000 sq.ft.
3. INDUS: proportion of nonretail business acres per town
4. CHAS: Charles River dummy variable (= 1 if tract bounds river; 0 otherwise)
5. NOX: nitric oxide concentration (parts per 10 million)
6. RM: average number of rooms per dwelling
7. AGE: proportion of owner-occupied units built prior to 1940
8. DIS: weighted distances to five Boston employment centers
9. RAD: index of accessibility to radial highways
10. TAX: full-value property tax rate per \$10,000
11. PTRATIO: pupil–teacher ratio by town
12. B:  $1000(B_k - 0.63)^2$ , where  $B_k$  is the proportion of blacks by town
13. LSTAT: % lower status of the population

The target variable is the median value of owner-occupied homes in thousands of dollars. In this example we try to predict the target variable by using some linear combination of these 13 features.

First, we import the data:

```
from sklearn import datasets, metrics, preprocessing
boston = datasets.load_boston()
x_data = preprocessing.StandardScaler().fit_transform(boston.data)
y_data = boston.target
```

Next, we use the same linear regression model as in [Chapter 3](#). This time we track the “loss” so we can measure the mean squared error (MSE), which is the average of the squared differences between the real target value and our predicted value. We use this measure as an indicator of how well our model performs:

```
x = tf.placeholder(tf.float64,shape=(None,13))
y_true = tf.placeholder(tf.float64,shape=(None))

with tf.name_scope('inference') as scope:
    w = tf.Variable(tf.zeros([1,13],dtype=tf.float64,name='weights'))
    b = tf.Variable(0,dtype=tf.float64,name='bias')
    y_pred = tf.matmul(w,tf.transpose(x)) + b

with tf.name_scope('loss') as scope:
    loss = tf.reduce_mean(tf.square(y_true-y_pred))

with tf.name_scope('train') as scope:
    learning_rate = 0.1
    optimizer = tf.train.GradientDescentOptimizer(learning_rate)
    train = optimizer.minimize(loss)

init = tf.global_variables_initializer()
with tf.Session() as sess:
    sess.run(init)
    for step in range(200):
        sess.run(train,{x: x_data, y_true: y_data})

    MSE = sess.run(loss,{x: x_data, y_true: y_data})
print(MSE)

Out:
MSE = 21.9036388397
```

After 200 iterations, we print out the MSE calculated for the training set. Now we perform the exact same process, but using `contrib.learn`'s estimator for linear regression. The whole process of defining, fitting, and evaluating the model comes down to just a few lines:

1. The linear regression model is instantiated using `learn.LinearRegressor()` and fed with knowledge about the data representation and the type of optimizer:

```
reg = learn.LinearRegressor(
    feature_columns=feature_columns,
    optimizer=tf.train.GradientDescentOptimizer(
        learning_rate=0.1)
)
```

2. The regressor object is trained using `.fit()`. We pass the covariates and the target variable, and set the number of steps and batch size:

```
reg.fit(x_data, boston.target, steps=NUM_STEPS,  
       batch_size=MINIBATCH_SIZE)
```

3. The MSE loss is returned by `.evaluate()`:

```
MSE = regressor.evaluate(x_data, boston.target, steps=1)
```

Here's the code in its entirety:

```
NUM_STEPS = 200  
MINIBATCH_SIZE = 506  
  
feature_columns = learn.infer_real_valued_columns_from_input(x_data)  
  
reg = learn.LinearRegressor(  
    feature_columns=feature_columns,  
    optimizer=tf.train.GradientDescentOptimizer(  
        learning_rate=0.1)  
)  
  
reg.fit(x_data, boston.target, steps=NUM_STEPS,  
       batch_size=MINIBATCH_SIZE)  
  
MSE = reg.evaluate(x_data, boston.target, steps=1)  
  
print(MSE)
```

```
Out:  
{'loss': 21.902138, 'global_step': 200}
```

Some representation of the input data is passed in the regressor instantiation as a processed variable called `feature_columns`. We will return to this shortly.

## DNN Classifier

As with regression, we can use `contrib.learn` to apply an out-of-the-box classifier. In [Chapter 2](#) we created a simple softmax classifier for the MNIST data. The `DNNClassifier` estimator allows us to perform a similar task with a considerably reduced amount of code. Also, it lets us add hidden layers (the “deep” part of the DNN).

As in [Chapter 2](#), we first import the MNIST data:

```
import sys  
import numpy as np  
from tensorflow.examples.tutorials.mnist import input_data  
DATA_DIR = '/tmp/data' if not 'win32' in sys.platform else "c:\\tmp\\data"  
data = input_data.read_data_sets(DATA_DIR, one_hot=False)  
x_data, y_data = data.train.images, data.train.labels.astype(np.int32)  
x_test, y_test = data.test.images, data.test.labels.astype(np.int32)
```

Note that in this case, due to the requirement of the estimator, we pass the target in its class label form:



```
one_hot=False
```

returning a single integer per sample, corresponding to the correct digit class (i.e., values from 0 to [number of classes] - 1), instead of the one-hot form where each label is a vector with 1 in the index that corresponds to the correct class.

The next steps are similar to the ones we took in the previous example, except that when we define the model, we add the number of classes (10 digits) and pass a list where each element corresponds to a hidden layer with the specified number of units. In this example we use one hidden layer with 200 units:

```
NUM_STEPS = 2000
MINIBATCH_SIZE = 128

feature_columns = learn.infer_real_valued_columns_from_input(x_data)

dnn = learn.DNNClassifier(
    feature_columns=feature_columns,
    hidden_units=[200],
    n_classes=10,
    optimizer=tf.train.ProximalAdagradOptimizer(
        learning_rate=0.2)
)

dnn.fit(x=x_data,y=y_data, steps=NUM_STEPS,
        batch_size=MINIBATCH_SIZE)

test_acc = dnn.evaluate(x=x_test,y=y_test, steps=1)["accuracy"]
print('test accuracy: {}'.format(test_acc))

Out:
test accuracy: 0.977
```

Though not as good as our CNN model in [Chapter 4](#) (above 99%), the test accuracy here (around 98%) is significantly better than it was in the simple softmax example (around 92%) as a result of adding just a single layer. In [Figure 7-1](#) we see how the accuracy of the model increases with the number of units in that hidden layer.

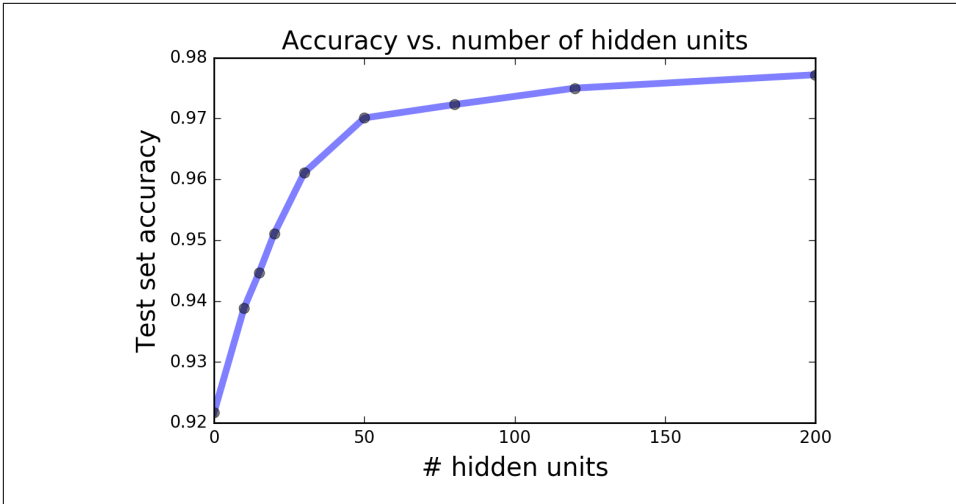

Figure 7-1. MNIST classification test accuracy as a function of units added in a single hidden layer.

Using the `<Estimator>.predict()` method, we can predict the classes of new samples. Here we will use the predictions to demonstrate how we can analyze our model's performance—what classes were best identified and what types of typical errors were made. Plotting a *confusion matrix* can help us understand these behaviors. We import the code to create the confusion matrix from the `skikit-learn` library:

```
from sklearn.metrics import confusion_matrix

y_pred = dnn.predict(x=x_test,as_iterable=False)
class_names = ['0','1','2','3','4','5','6','7','8','9']
cnf_matrix = confusion_matrix(y_test, y_pred)
```

The confusion matrix is shown in [Figure 7-2](#). Its rows correspond to the true digits, its columns to the predicted digits. We see, for example, that the model sometimes misclassified 5 as 3 and 9 as 4 and 7.

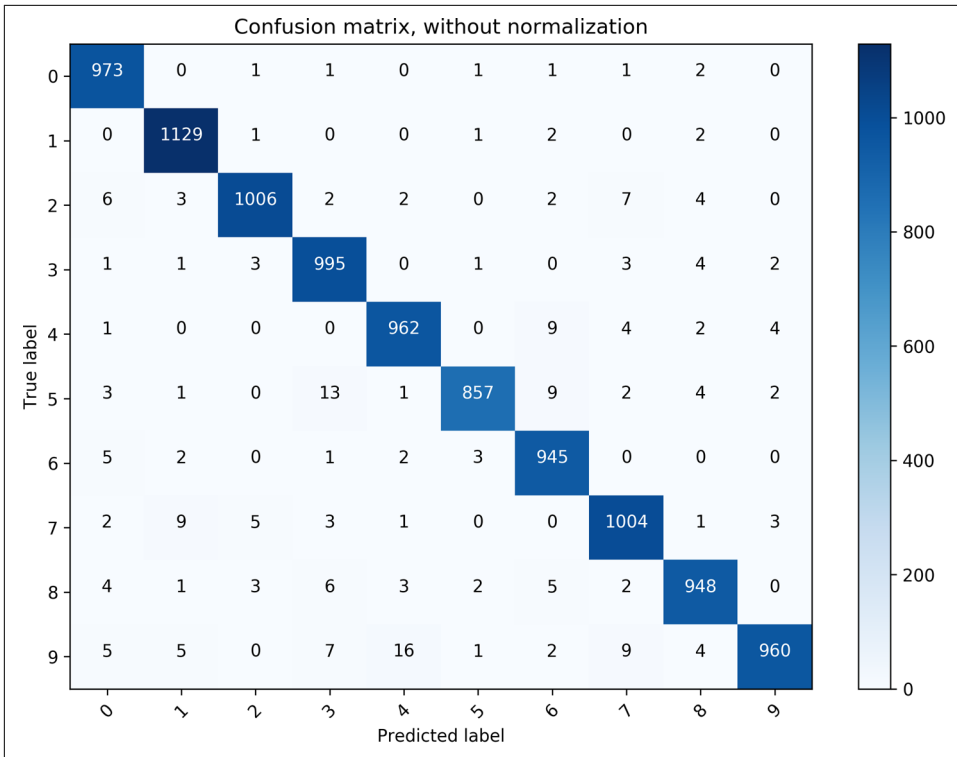

Figure 7-2. A confusion matrix showing the number of predicted digits (columns) for each true label (rows).

## FeatureColumn

One of contrib.learn’s nicest offerings is handling features of different types, which can sometimes be a little tricky. To make things easier, contrib.learn offers us the FeatureColumn abstraction.

With a FeatureColumn we can maintain a representation of a single feature in our data, while performing a range of transformations defined over it. A FeatureColumn can be either one of the original columns or any new columns that may be added depending on our transformations. These may include creating a suitable and effective representation for categorical data by encoding it as a sparse vector (often referred to as *dummy encoding*), creating feature crosses to look for feature interactions, and bucketization (discretization of the data). All this can be done while manipulating the feature as a single semantic unit (encompassing, for example, all dummy vectors).

We use the FeatureColumn abstraction to specify the form and structure of each feature of our input data. For instance, let’s say that our target variable is height, and we

try to predict it using two features, weight and species. We make our own synthetic data where heights are generated by dividing each weight by a factor of 100 and adding a constant that varies according to the species: 1 is added for Humans, 0.9 for Goblins, and 1.1 for ManBears. We then add normally distributed noise to each instance:

```
import pandas as pd
N = 10000

weight = np.random.randn(N)*5+70
spec_id = np.random.randint(0,3,N)
bias = [0.9,1,1.1]
height = np.array([weight[i]/100 + bias[b] for i,b in enumerate(spec_id)])
spec_name = ['Goblin','Human','ManBears']
spec = [spec_name[s] for s in spec_id]
```

Figure 7-3 shows visualizations of the data samples.

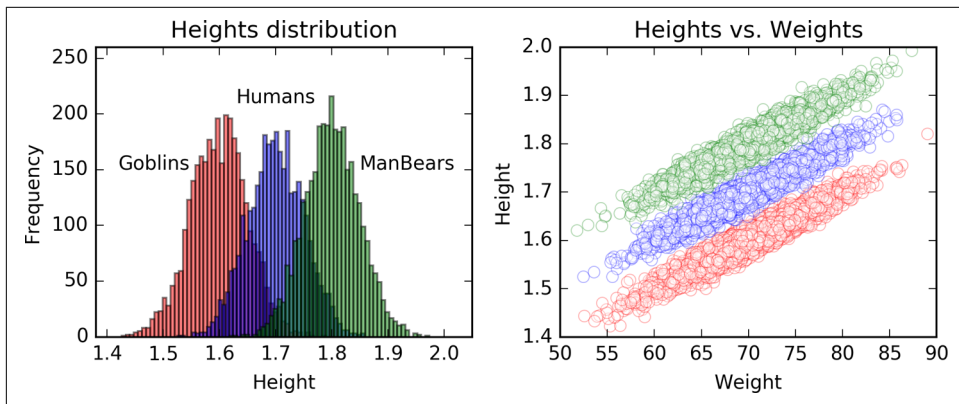

Figure 7-3. Left: A histogram of heights for the three types of species: Goblins, Humans, and ManBears (distributions centered at 1.6, 1.7, and 1.8, respectively). Right: A scatter plot of heights vs. weights.

Our target variable is a numeric NumPy array of heights `height`, and our covariates are the numeric NumPy array of weights `weight` and a list of strings denoting the name of each species `spec`.

We use the Pandas library to have the data represented as a data frame (table), so that we can conveniently access each of its columns:

```
df = pd.DataFrame({'Species':spec,'Weight':weight,'Height':height})
```

Figure 7-4 shows what our data frame looks like.

	Height	Species	Weight
0	1.768	ManBears	67.57
1	1.65	Goblin	73.79
2	1.55	Goblin	67.58
3	1.608	Goblin	70.01
4	1.679	Human	67.17
5	1.635	Goblin	71.65
6	1.742	ManBears	64.28
7	1.667	Human	66.55
8	1.669	Human	64.79
9	1.776	ManBears	68.91

Figure 7-4. Ten rows of the Height–Species–Weight data frame. Heights and Weights are numeric; Species is categorical with three categories.



### Pandas

Pandas is a very popular and useful library in Python for working with relational or labeled data like tabular data, multidimensional time series, etc. For more information on how to use Pandas, we refer the reader to Wes McKinney’s book *Python for Data Analysis* (O’Reilly).

We start by specifying the nature of each feature. For `Weight` we use the following `FeatureColumn` command, indicating that it’s a continuous variable:

```
from tensorflow.contrib import layers
Weight = layers.real_valued_column("Weight")
```



### Layers

`contrib.layers` is not a part of `contrib.learn`, but another independent subsection of the TensorFlow Python API that offers high-level operations and tools for building neural network layers.

The name that was passed to the function (in this case `Weight`) is crucially important since it will be used to associate the `FeatureColumn` representation with the actual data.

`Species` is a categorical variable, meaning its values have no natural ordering, and therefore cannot be represented as a single variable in the model. Instead, it has to be extended and encoded as several variables, depending on the number of categories. `FeatureColumn` does this for us, so we just have to use the following command to specify that it is a categorical feature and indicate the name of each category:

```
Species = layers.sparse_column_with_keys(
    column_name="Species", keys=['Goblin', 'Human', 'ManBears'])
```

Next, we instantiate an estimator class and input a list of our FeatureColumns:

```
reg = learn.LinearRegressor(feature_columns=[Weight,Species])
```

Up to now we've defined how the data will be represented in the model; in the following stage of fitting the model we need to provide the actual training data. In the Boston Housing example, the features were all numeric, and as a result we could just input them as `x_data` and target data.

Here, `contrib.learn` requires that we use an additional encapsulating input function. The function gets both predictors and target data in their native form (Pandas data frame, NumPy array, list, etc.) as input, and returns a dictionary of tensors. In these dictionaries, each key is a name of a FeatureColumn (the names `Weight` and `Species` that were given as input previously), and its value needs to be a Tensor that contains the corresponding data. This means that we also have to transform the values into a TensorFlow Tensor inside the function.

In our current example, the function receives our data frame, creates a dictionary `feature_cols`, and then stores the values of each column in the data frame as a Tensor for the corresponding key. It then returns that dictionary and the target variable as a Tensor. The keys have to match the names we used to define our FeatureColumns:

```
def input_fn(df):
    feature_cols = {}
    feature_cols['Weight'] = tf.constant(df['Weight'].values)

    feature_cols['Species'] = tf.SparseTensor(
        indices=[[i, 0] for i in range(df['Species'].size)],
        values=df['Species'].values,
        dense_shape=[df['Species'].size, 1])

    labels = tf.constant(df['Height'].values)

    return feature_cols, labels
```

The values of `Species` are required by their FeatureColumn specification to be encoded in a sparse format. For that we use `tf.SparseTensor()`, where each `i` index corresponds to a nonzero value (in this case, all the rows in a one-column matrix).

For example, the following:

```
SparseTensor(indices=[[0, 0], [2, 1], [2, 2]], values=[2, 5, 7],
             dense_shape=[3, 3])
```

represents the dense tensor:

```
[[2, 0, 0]
 [0, 0, 0]
 [0, 5, 7]]
```

We pass it to the `.fit()` method in the following way:

```
reg.fit(input_fn=lambda:input_fn(df), steps=50000)
```

Here, `input_fn()` is the function we just created, `df` is the data frame containing the data, and we also specify the number of iterations.

Note that we pass the function in a form of a `lambda` function rather than the function's outputs, because the `.fit()` method requires a function object. Using `lambda` allows us to pass our input arguments and keep it in an object form. There are other workarounds we could use to achieve the same outcome, but `lambda` does the trick.

The fitting process may take a while. If you don't want to do it all at once, you can split it into segments (see the following note).



### Splitting the training process

It's possible to perform the fit iteratively since the state of the model is preserved in the classifier. For example, instead of performing all 50,000 iterations consecutively like we did, we could split it into five segments:

```
reg.fit(input_fn=lambda:input_fn(df), steps=10000)
reg.fit(input_fn=lambda:input_fn(df), steps=10000)
reg.fit(input_fn=lambda:input_fn(df), steps=10000)
reg.fit(input_fn=lambda:input_fn(df), steps=10000)
reg.fit(input_fn=lambda:input_fn(df), steps=10000)
```

and achieve the same outcome. This could be useful if we want to have some tracking of the model while training it; however, there are better ways to do that, as we will see later on.

Now let's see how well the model does by looking at the estimated weights. We can use the `.get_variable_value()` method to get the variables' values:

```
w_w = reg.get_variable_value('linear/Weight/weight')
print('Estimation for Weight: {}'.format(w_w))

s_w = reg.get_variable_value('linear/Species/weights')
b = reg.get_variable_value('linear/bias_weight')
print('Estimation for Species: {}'.format(s_w + b))
```

Out:

```
Estimation for Weight: [[0.00992305]]
Estimation for Species: [[0.90493023]
 [1.00566959]
 [1.10534406]]
```

We request the values of the weights for both `Weight` and `Species`. `Species` is a categorical variable, so its three weights serve as different bias terms. We see that the model did quite well in estimating the true weights (0.01 for `Weight` and 0.9, 1, 1.1 for `Goblins`, `Humans`, and `ManBears`, respectively, for `Species`). We can get the names of the variables by using the `.get_variable_names()` method.

The same process can be used in more complicated scenarios where we want to handle many types of features and their interactions. [Table 7-2](#) lists some useful operations you can do with `contrib.learn`.

*Table 7-2. Useful feature transformation operations*

Operation	Description
<code>layers.sparse_column_with_keys()</code>	Handles the conversion of categorical values
<code>layers.sparse_column_with_hash_bucket()</code>	Handles the conversion of categorical features for which you don't know all possible values
<code>layers.crossed_column()</code>	Sets up feature crosses (interactions)
<code>layers.bucketized_column()</code>	Turns a continuous column into a categorical column

## Homemade CNN with `contrib.learn`

We next move on to creating our own estimator by using `contrib.learn`. To do so, we first need to construct a model function where our homemade network will reside and an object containing our training settings.

In the following example we create a custom CNN estimator that is identical to the one used at the beginning of [Chapter 4](#), and use it again to classify the MNIST data. We begin by creating a function for our estimator with inputs that include our data, the mode of operation (training or test), and the parameters of the model.

In the MNIST data the pixels are concatenated in the form of a vector and therefore require that we reshape them:

```
x_image = tf.reshape(x_data, [-1, 28, 28, 1])
```

We build the network by using the `contrib.layers` functionality, making the process of layer construction simpler.

Using `layers.convolution2d()` we can set everything in a one-liner command: we pass the input (the output of the previous layer), and then indicate the number of feature maps (32), the size of the filter (5×5), and the activation function (`relu`), and initialize the weights and biases. The dimensionality of the input is automatically identified and does not need to be specified. Also, unlike when working in lower-level TensorFlow, we don't need to separately define the shapes of the variables and biases:



```
conv1 = layers.convolution2d(x_image, 32, [5,5],
                             activation_fn=tf.nn.relu,
                             biases_initializer=tf.constant_initializer(0.1),
                             weights_initializer=tf.truncated_normal_initializer(stddev=0.1))
```

The padding is set to 'SAME' by default (unchanged number of pixels), resulting in an output of shape 28×28×32.

We also add the standard 2×2 pooling layer:

```
pool1 = layers.max_pool2d(conv1, [2,2])
```

We then repeat these steps, this time for 64 target feature maps:

```
conv2 = layers.convolution2d(pool1, 64, [5,5],
                             activation_fn=tf.nn.relu,
                             biases_initializer=tf.constant_initializer(0.1),
                             weights_initializer=tf.truncated_normal_initializer(stddev=0.1))

pool2 = layers.max_pool2d(conv2, [2,2])
```

Next, we flatten the 7×7×64 tensor and add a fully connected layer, reducing it to 1,024 entries. We use `fully_connected()` similarly to `convolution2d()`, except we specify the number of output units instead of the size of the filter (there's just one of those):

```
pool2_flat = tf.reshape(pool2, [-1, 7*7*64])
fc1 = layers.fully_connected(pool2_flat, 1024,
                             activation_fn=tf.nn.relu,
                             biases_initializer=tf.constant_initializer(0.1),
                             weights_initializer=tf.truncated_normal_initializer(stddev=0.1))
```

We then add dropout with `keep_prob` as set in the parameters given to the function (train/test mode), and the final fully connected layer with 10 output entries, corresponding to the 10 classes:

```
fc1_drop = layers.dropout(fc1, keep_prob=params["dropout"],
                          is_training=(mode == 'train'))
y_conv = layers.fully_connected(fc1_drop, 10, activation_fn=None)
```

We complete our model function by defining a training object with the loss and the learning rate of the optimizer.

We now have one function that encapsulates the entire model:

```
def model_fn(x, target, mode, params):
    y_ = tf.cast(target, tf.float32)
    x_image = tf.reshape(x, [-1, 28, 28, 1])

    # Conv layer 1
    conv1 = layers.convolution2d(x_image, 32, [5,5],
                                 activation_fn=tf.nn.relu,
                                 biases_initializer=tf.constant_initializer(0.1),
                                 weights_initializer=tf.truncated_normal_initializer(stddev=0.1))
```

```

pool1 = layers.max_pool2d(conv1, [2,2])

# Conv layer 2
conv2 = layers.convolution2d(pool1, 64, [5,5],
    activation_fn=tf.nn.relu,
    biases_initializer=tf.constant_initializer(0.1),
    weights_initializer=tf.truncated_normal_initializer(stddev=0.1))
pool2 = layers.max_pool2d(conv2, [2,2])

# FC layer
pool2_flat = tf.reshape(pool2, [-1, 7*7*64])
fc1 = layers.fully_connected(pool2_flat, 1024,
    activation_fn=tf.nn.relu,
    biases_initializer=tf.constant_initializer(0.1),
    weights_initializer=tf.truncated_normal_initializer(stddev=0.1))
fc1_drop = layers.dropout(fc1, keep_prob=params["dropout"],
    is_training=(mode == 'train'))

# Readout layer
y_conv = layers.fully_connected(fc1_drop, 10, activation_fn=None)

cross_entropy = tf.reduce_mean(
    tf.nn.softmax_cross_entropy_with_logits(logits=y_conv, labels=y_))
train_op = tf.contrib.layers.optimize_loss(
    loss=cross_entropy,
    global_step=tf.contrib.framework.get_global_step(),
    learning_rate=params["learning_rate"],
    optimizer="Adam")

predictions = tf.argmax(y_conv, 1)
return predictions, cross_entropy, train_op

```

We instantiate the estimator by using `contrib.learn.Estimator()`, and we're good to go. Once defined, we can use it with the same functionalities as before:

```

from tensorflow.contrib import layers

data = input_data.read_data_sets(DATA_DIR, one_hot=True)
x_data, y_data = data.train.images, np.int32(data.train.labels)
tf.cast(x_data, tf.float32)
tf.cast(y_data, tf.float32)

model_params = {"learning_rate": 1e-4, "dropout": 0.5}

CNN = tf.contrib.learn.Estimator(
    model_fn=model_fn, params=model_params)

print("Starting training for %s steps max" % 5000)
CNN.fit(x=data.train.images,
    y=data.train.labels, batch_size=50,
    max_steps=5000)

test_acc = 0

```

```
for ii in range(5):
    batch = data.test.next_batch(2000)
    predictions = list(CNN.predict(batch[0], as_iterable=True))
    test_acc = test_acc + (np.argmax(batch[1],1) == predictions).mean()

print(test_acc/5)
```

```
Out:
0.9872
```

Using `contrib.learn` and `contrib.layers`, the number of lines of code was cut down considerably in comparison to lower-level TensorFlow. More important, the code is much more organized and easier to follow, debug, and write.

With this example we conclude the `contrib.learn` portion of this chapter. We'll now move on to cover some of the functionalities of the TFLearn library.

## TFLearn

TFLearn is another library that allows us to create complex custom models in a very clean and compressed way, while still having a reasonable amount of flexibility, as we will see shortly.

## Installation

Unlike the previous library, TFLearn first needs to be installed. The installation is straightforward using `pip`:

```
pip install tflearn
```

If that doesn't work, it can be downloaded from [GitHub](#) and installed manually.

After the library has been successfully installed, you should be able to import it:

```
import tflearn
```

## CNN

Many of the functionalities of TFLearn resemble those covered in the previous section on `contrib.learn`; however, creating a custom model is a bit simpler and cleaner in comparison. In the following code we use the same CNN used earlier for the MNIST data.

Model construction is wrapped and finalized using `regression()`, where we set the loss and optimization configuration as we did previously for the training object in `contrib.learn` (here we simply specify `'categorical_crossentropy'` for the loss, rather than explicitly defining it):

```

from tflearn.layers.core import input_data, dropout, fully_connected
from tflearn.layers.conv import conv_2d, max_pool_2d
from tflearn.layers.normalization import local_response_normalization
from tflearn.layers.estimator import regression

# Data loading and basic transformations
import tflearn.datasets.mnist as mnist
X, Y, X_test, Y_test = mnist.load_data(one_hot=True)
X = X.reshape([-1, 28, 28, 1])
X_test = X_test.reshape([-1, 28, 28, 1])

# Building the network
CNN = input_data(shape=[None, 28, 28, 1], name='input')
CNN = conv_2d(CNN, 32, 5, activation='relu', regularizer="L2")
CNN = max_pool_2d(CNN, 2)
CNN = local_response_normalization(CNN)
CNN = conv_2d(CNN, 64, 5, activation='relu', regularizer="L2")
CNN = max_pool_2d(CNN, 2)
CNN = local_response_normalization(CNN)
CNN = fully_connected(CNN, 1024, activation=None)
CNN = dropout(CNN, 0.5)
CNN = fully_connected(CNN, 10, activation='softmax')
CNN = regression(CNN, optimizer='adam', learning_rate=0.0001,
                  loss='categorical_crossentropy', name='target')

# Training the network
model = tflearn.DNN(CNN, tensorboard_verbose=0,
                    tensorboard_dir = 'MNIST_tflearn_board/',
                    checkpoint_path = 'MNIST_tflearn_checkpoints/checkpoint')
model.fit({'input': X}, {'target': Y}, n_epoch=3,
        validation_set=({'input': X_test}, {'target': Y_test}),
        snapshot_step=1000, show_metric=True, run_id='convnet_mnist')

```

Another layer that’s been added here, and that we briefly mentioned in [Chapter 4](#), is the local response normalization layer. See the upcoming note for more details about this layer.

The `tflearn.DNN()` function is somewhat equivalent to `contrib.learn.Estimator()`—it’s the DNN model wrapper with which we instantiate the model and to which we pass our constructed network.

Here we can also set the TensorBoard and checkpoints directories, the level of verbosity of TensorBoard’s logs (0–3, from basic loss and accuracy reports to other measures like gradients and weights), and other settings.

Once we have a model instance ready, we can then perform standard operations with it. [Table 7-3](#) summarizes the model’s functionalities in TFLearn.

Table 7-3. Standard TFLearn operations

Function	Description
<code>evaluate(X, Y, batch_size=128)</code>	Perform evaluations of the model on given samples.
<code>fit(X, Y, n_epoch=10)</code>	Train the model with input features $X$ and target $Y$ to the network.
<code>get_weights(weight_tensor)</code>	Get a variable's weights.
<code>load(model_file)</code>	Restore model weights.
<code>predict(X)</code>	Get model predictions for the given input data.
<code>save(model_file)</code>	Save model weights.
<code>set_weights(tensor, weights)</code>	Assign a tensor variable a given value.

Similarly with `contrib.learn`, the fitting operation is performed by using the `.fit()` method, to which we feed the data and control training settings: the number of epochs, training and validation batch sizes, displayed measures, saved summaries frequency, and more. During fitting, TFLearn displays a nice dashboard, enabling us to track the training process online.



### Local response normalization

The local response normalization (LRN) layer performs a kind of *lateral inhibition* by normalizing over local input regions. This is done by dividing the input values by the weighted, squared sum of all inputs within some depth radius, which we can manually choose. The resulting effect is that the activation contrast between the excited neurons and their local surroundings increases, producing more salient local maxima. This method encourages inhibition since it will diminish activations that are large, but uniform. Also, normalization is useful to prevent neurons from saturating when inputs may have varying scale (ReLU neurons have unbounded activation). There are more modern alternatives for regularization, such as batch normalization and dropout, but it is good to know about LRN too.

After fitting the model, we evaluate performance on the test data:

```
evaluation = model.evaluate({'input': X_test}, {'target': Y_test})
print(evaluation):
```

```
Out:
0.9862
```

and form new predictions (using them here again as a “sanity check” to the previous evaluation):

```
pred = model.predict({'input': X_test})
print((np.argmax(testY,1)==np.argmax(pred,1)).mean())
```

Out:  
0.9862



### Iterations training steps and epochs in TFLearn

In TFLearn, each *iteration* is a full pass (forward and backward) over one example. The *training step* is the number of full passes to perform, determined by the batch size you set (the default is 64), and an *epoch* is a full pass over all the training examples (50,000 in the case of MNIST). [Figure 7-5](#) shows an example of the interactive display in TFLearn.

```
Training Step: 77 | total loss: 0.63675 | time: 10.782s
| Adam | epoch: 001 | loss: 0.63675 - acc: 0.8058 -- iter: 04928/55000
```

Figure 7-5. Interactive display in TFLearn.

## RNN

We wrap up our introduction to TFLearn by constructing a fully functioning text classification RNN model that considerably simplifies the code we saw in Chapters 5 and 6.

The task we perform is a sentiment analysis for movie reviews with binary classification (good or bad). We will use a well-known dataset of IMDb reviews, containing 25,000 training samples and 25,000 test samples:

```
from tflearn.data_utils import to_categorical, pad_sequences
from tflearn.datasets import imdb

# IMDb dataset loading
train, test, _ = imdb.load_data(path='imdb.pkl', n_words=10000,
                                valid_portion=0.1)

X_train, Y_train = train
X_test, Y_test = test
```

We first prepare the data, which has different sequence lengths, by equalizing the sequences with zero-padding by using `tflearn.data_utils.pad_sequences()` and setting 100 as the maximum sequence length:

```
X_train = pad_sequences(X_train, maxlen=100, value=0.)
X_test = pad_sequences(X_test, maxlen=100, value=0.)
```

Now we can represent data in one tensor, with samples in its rows and word IDs in its columns. As was explained in [Chapter 5](#), IDs here are integers that are used to encode the actual words arbitrarily. In our case, we have 10,000 unique IDs.

Next, we embed each word into a continuous vector space by using `tflearn.embedding()`, transforming our two-dimensional tensor `[samples, IDs]` into a three-dimensional tensor, `[samples, IDs, embedding-size]`, where each word ID now corresponds to a vector of size of 128. Before that we use `input_data()` to input/feed data to the network (a TensorFlow placeholder is created with the given shape):

```
RNN = tflearn.input_data([None, 100])
RNN = tflearn.embedding(RNN, input_dim=10000, output_dim=128)
```

Finally, we add an LSTM layer and a fully connected layer to output the binary outcome:

```
RNN = tflearn.lstm(RNN, 128, dropout=0.8)
RNN = tflearn.fully_connected(RNN, 2, activation='softmax')
```

Here's the full code:

```
from tflearn.data_utils import to_categorical, pad_sequences
from tflearn.datasets import imdb

# Load data
train, test, _ = imdb.load_data(path='imdb.pkl', n_words=10000,
                               valid_portion=0.1)

X_train, Y_train = train
X_test, Y_test = test

# Sequence padding and converting labels to binary vectors
X_train = pad_sequences(X_train, maxlen=100, value=0.)
X_test = pad_sequences(X_test, maxlen=100, value=0.)
Y_train = to_categorical(Y_train, nb_classes=2)
Y_test = to_categorical(Y_test, nb_classes=2)

# Building an LSTM network
RNN = tflearn.input_data([None, 100])
RNN = tflearn.embedding(RNN, input_dim=10000, output_dim=128)

RNN = tflearn.lstm(RNN, 128, dropout=0.8)
RNN = tflearn.fully_connected(RNN, 2, activation='softmax')
RNN = tflearn.regression(RNN, optimizer='adam', learning_rate=0.001,
                          loss='categorical_crossentropy')

# Training the network
model = tflearn.DNN(RNN, tensorboard_verbose=0)
model.fit(X_train, Y_train, validation_set=(X_test, Y_test),
          show_metric=True, batch_size=32)
```

In this section, we had just a quick taste of TFLearn. The library has nice [documentation](#) and many examples that are well worth looking at.

## Keras

Keras is one of the most popular and powerful TensorFlow extension libraries. Among the extensions we survey in this chapter, Keras is the only one that supports both Theano—upon which it was originally built—and TensorFlow. This is possible because of Keras’s complete abstraction of its backend; Keras has its own graph data structure for handling computational graphs and communicating with TensorFlow.

In fact, because of that it could even be possible to define a Keras model with either TensorFlow or Theano and then switch to the other.

Keras has two main types of models to work with: sequential and functional. The sequential type is designed for simple architectures, where we just want to stack layers in a linear fashion. The functional API can support more-general models with a diverse layer structure, such as multioutput models.

We will take a quick look at the syntax used for each type of model.

### Installation

In TensorFlow 1.1+ Keras can be imported from the `contrib` library; however, for older versions it needs to be installed externally. Note that Keras requires the `numpy`, `scipy`, and `yaml` dependencies. Similarly to TFLearn, Keras can either be installed using `pip`:

```
pip install keras
```

or downloaded from [GitHub](#) and installed using:

```
python setup.py install
```

By default, Keras will use TensorFlow as its tensor manipulation library. If it is set to use Theano, it can be switched by changing the settings in the file called `$HOME/.keras/keras.json` (for Linux users—modify the path according to your OS), where the attribute `backend` appears in addition to other technical settings not important in this chapter:

```
{
  "image_data_format": "channels_last",
  "epsilon": 1e-07,
  "floatx": "float32",
  "backend": "tensorflow"
}
```

If we want to access the backend, we can easily do so by first importing it:



```
from keras import backend as K
```

We can then use it for most tensor operations as we would in TensorFlow (also for Theano). For example, this:

```
input = K.placeholder(shape=(10,32))
```

is equivalent to:

```
tf.placeholder(shape=(10,32))
```

## Sequential model

Using the sequential type is very straightforward—we define it and can simply start adding layers:

```
from keras.models import Sequential
from keras.layers import Dense, Activation

model = Sequential()

model.add(Dense(units=64, input_dim=784))
model.add(Activation('softmax'))
```

Or equivalently:

```
model = Sequential([
    Dense(64, input_shape=(784,), activation='softmax')
])
```

A *dense* layer is a fully connected layer. The first argument denotes the number of output units, and the input shape is the shape of the input (in this example the weight matrix would be of size 784×64). `Dense()` also has an optional argument where we can specify and add an activation function, as in the second example.

After the model is defined, and just before training it, we set its learning configurations by using the `.compile()` method. It has three input arguments—the loss function, the optimizer, and another metric function that is used to judge the performance of your model (not used as the actual loss when training the model):

```
model.compile(loss='categorical_crossentropy',
              optimizer='sgd',
              metrics=['accuracy'])
```

We can set the optimizer at a finer resolution (learning rate, method, etc.) using `.optimizers`. For example:

```
optimizer=keras.optimizers.SGD(lr=0.02, momentum=0.8, nesterov=True))
```

Finally, we feed `.fit()` the data and set the number of epochs and batch size. As with the previous libraries, we can now easily evaluate how it does and perform predictions with new test data:

```

from keras.callbacks import TensorBoard, EarlyStopping, ReduceLRonPlateau

early_stop = EarlyStopping(monitor='val_loss', min_delta=0,
                           patience=10, verbose=0, mode='auto')

model.fit(x_train, y_train, epochs=10, batch_size=64,
          callbacks=[TensorBoard(log_dir='/models/autoencoder',)
                    early_stop])

loss_and_metrics = model.evaluate(x_test, y_test, batch_size=64)
classes = model.predict(x_test, batch_size=64)

```

Note that a `callbacks` argument was added to the `fit()` method. Callbacks are functions that are applied during the training procedure, and we can use them to get a view on statistics and make dynamic training decisions by passing a list of them to the `.fit()` method.

In this example we plug in two callbacks: `TensorBoard`, specifying its output folder, and `early stopping`.



### Early stopping

Early stopping is used to protect against overfitting by preventing the learner from further improving its fit to the training data at the expense of increasing the generalization error. In that sense, it can be thought of as a form of regularization. In Keras we can specify the minimum change to be monitored (`min_delta`), the number of no-improvement epochs to stop after (`patience`), and the direction of wanted change (`mode`).

## Functional model

The main practical difference between the functional model and the sequential model is that here we first define our input and output, and only then instantiate the model.

We first create an input `Tensor` according to its shape:

```
inputs = Input(shape=(784,))
```

Then we define our model:

```

x = Dense(64, activation='relu')(inputs)
x = Dense(32, activation='relu')(x)
outputs = Dense(10, activation='softmax')(x)

```

As we can see, the layers act as functions, giving the functional model its name.

And now we instantiate the model, passing both inputs and outputs to `Model`:

```
model = Model(inputs=inputs, outputs=outputs)
```

The other steps follow as before:

```
model.compile(optimizer='rmsprop',
              loss='categorical_crossentropy',
              metrics=['accuracy'])
model.fit(x_train, y_train, epochs=10, batch_size=64)
loss_and_metrics = model.evaluate(x_test, y_test, batch_size=64)
classes = model.predict(x_test, batch_size=64)
```

We will end this section by introducing the concept of autoencoders and then showing how to implement one using Keras.

## Autoencoders

*Autoencoders* are neural networks that try to output a reconstruction of the input. In most cases the input is reconstructed after having its dimensionality reduced. Dimensionality reduction will be our main focus; however, autoencoders can also be used to achieve “overcomplete” representations (for more stable decomposition), which actually increases dimensions.

In dimensionality reduction we wish to translate each vector of data with size  $n$  to a vector with size  $m$ , where  $m < n$ , while trying to keep as much important information as possible. One very common way to do that is using principal component analysis (PCA), where we can represent each original data column  $x_j$  (all data points corresponding to an original feature) with some linear combination of the new reduced features, called the *principal components*, such that  $x_j = \sum_{i=1}^m w_i b_i$ .

PCA, however, is limited to only linear transformation of the data vectors.

Autoencoders are more general compressors, allowing complicated nonlinear transformations and finding nontrivial relations between visible and hidden units (in fact, PCA is like a one-layer “linear autoencoder”). The weights of the models are learned automatically by reducing a given loss function with an optimizer (SGD, for example).

Autoencoders that reduce input dimensionality create a bottleneck layer called a *hidden layer* that has a smaller number of units than the input layer, forcing the data to be represented in a lower dimension (Figure 7-6) before it is reconstructed. For the reconstruction (decoding), autoencoders extract representative features that capture some hidden abstractions, like the shape of an eye, wheel of a car, type of sport, etc., with which we can reconstruct the original input.

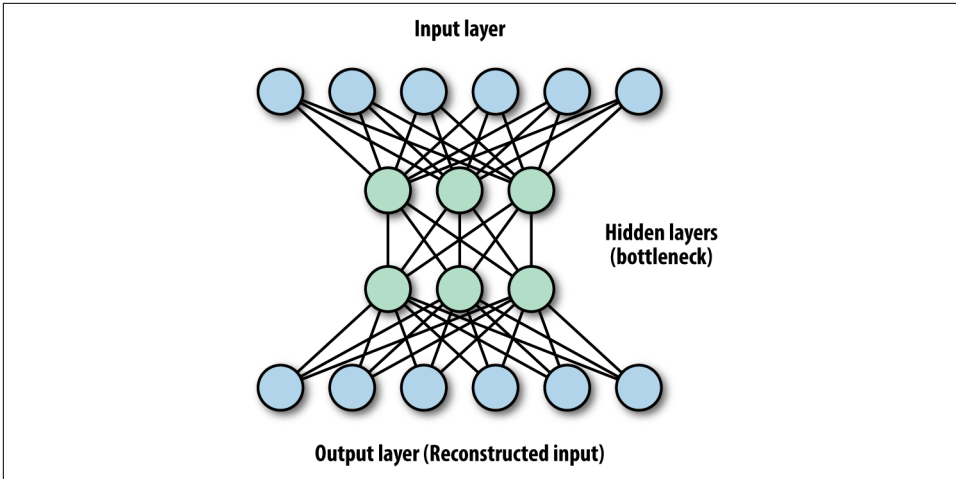

Figure 7-6. Illustration of an autoencoder—a typical autoencoder will have input and output layers consisting of the same number of units, and bottleneck hidden layers, where the dimensionality of the data is reduced (compressed).

Like some of the models we’ve seen so far, autoencoder networks can have layers stacked on top of each other, and they can include convolutions as in CNNs.

Autoencoders are currently not very suitable for real-world data compression problems due to their data specificity—they are best used on data that is similar to what they were trained on. Their current practical applications are mostly for extracting lower-dimensional representations, denoising data, and data visualization with reduced dimensionality. Denoising works because the network learns the important abstractions of the image, while losing unimportant image-specific signals like noise.

Now let’s build a toy CNN autoencoder with Keras. In this example we will train the autoencoder on one category of a noisy version of the CIFAR10 data images, and then use it to denoise a test set of the same category. In this example we will use the functional model API.

First we load the images by using Keras, and then we choose only the images that correspond to the label 1 (the automobile class):

```
from keras.layers import Input, Conv2D, MaxPooling2D, UpSampling2D
from keras.models import Model
from keras.callbacks import TensorBoard, ModelCheckpoint
from keras.datasets import cifar10
import numpy as np

(x_train, y_train), (x_test, y_test) = cifar10.load_data()
x_train = x_train[np.where(y_train==1)[0],:,:,:]
x_test = x_test[np.where(y_test==1)[0],:,:,:]
```

Next we do a little pre-processing, by first converting our data to `float32` and then normalizing it to a range between `[0,1]`. This normalization will allow us to perform an element-wise comparison at the pixel level, as we will see shortly. First, the type conversion:

```
x_train = x_train.astype('float32') / 255.  
x_test = x_test.astype('float32') / 255.
```

We then add some Gaussian noise to create the noisy dataset, and clip values that are either smaller than 0 or larger than 1:

```
x_train_n = x_train + 0.5 *\  
    np.random.normal(loc=0.0, scale=0.4, size=x_train.shape)  
  
x_test_n = x_test + 0.5 *\  
    np.random.normal(loc=0.0, scale=0.4, size=x_test.shape)  
  
x_train_n = np.clip(x_train_n, 0., 1.)  
x_test_n = np.clip(x_test_n, 0., 1.)
```

Now we declare the input layer (every image in the CIFAR10 dataset is 32×32 pixels with RGB channels):

```
inp_img = Input(shape=(32, 32, 3))
```

Next, we start adding our usual “LEGO brick” layers. Our first layer is a 2D convolution layer, where the first argument is the number of filters (and thus the number of output images), and the second is the size of each filter. Like the other libraries, Keras automatically identifies the shape of the input.

We use a 2×2 pooling layer, which reduces the total number of pixels per channel by 4, creating the desired bottleneck. After another convolutional layer, we regain the same number of units for each channel by applying an up-sampling layer. This is done by quadrupling each pixel in a pixel’s near vicinity (repeating the rows and columns of the data) to get back the same number of pixels in each image.

Finally, we add a convolutional output layer where we go back to three channels:

```
img = Conv2D(32, (3, 3), activation='relu', padding='same')(inp_img)  
img = MaxPooling2D((2, 2), padding='same')(img)  
img = Conv2D(32, (3, 3), activation='relu', padding='same')(img)  
img = UpSampling2D((2, 2))(img)  
decoded = Conv2D(3, (3, 3), activation='sigmoid', padding='same')(img)
```

We declare the functional model format, passing both inputs and outputs:

```
autoencoder = Model(inp_img, decoded)
```

Next we compile the model, defining the loss function and the optimizer—in this case we use the Adagrad optimizer (just to show another example!). For denoising of the images, we want our loss to capture the discrepancy between the decoded images and

the original, pre-noise images. For that we use a binary cross-entropy loss, comparing each decoded pixel to its corresponding original one (it's now between [0,1]):

```
autoencoder.compile(optimizer='adadelata', loss='binary_crossentropy')
```

After the model is defined, we fit it with 10 training epochs:

```
tensorboard = TensorBoard(log_dir='<some_path>',
                           histogram_freq=0, write_graph=True, write_images=True)
model_saver = ModelCheckpoint(
    filepath='<some_path>',
    verbose=0, period=2)

autoencoder.fit(x_train_n, x_train,
               epochs=10,
               batch_size=64,
               shuffle=True,
               validation_data=(x_test_n, x_test),
               callbacks=[tensorboard, model_saver])
```

Hopefully the model will capture some internal structure, which it can later generalize to other noisy images, and denoise them as a result.

We use our test set as validation data for loss evaluation at the end of each epoch (the model will not be trained on this data), and also for visualization in TensorBoard. In addition to the TensorBoard callback, we add a model saver callback and set it to save our weights every two epochs.

Later, when we wish to load our weights, we need to reconstruct the network and then use the `Model.load_weights()` method, passing our model as the first argument and our saved weights file path as the second (more on saving models in [Chapter 10](#)):

```
inp_img = Input(shape=(32, 32, 3))
img = Conv2D(32, (3, 3), activation='relu', padding='same')(inp_img)
img = MaxPooling2D((2, 2), padding='same')(img)
img = Conv2D(32, (3, 3), activation='relu', padding='same')(img)
img = UpSampling2D((2, 2))(img)
decoded = Conv2D(3, (3, 3), activation='sigmoid', padding='same')(img)

autoencoder = Model(inp_img, decoded)
Model.load_weights(autoencoder, 'some_path')
```



### h5py requirement

For model saving, it is required that the h5py package is installed. This package is primarily used for storing large amounts of data and manipulating it from NumPy. You can install it using pip:

```
pip install h5py
```

Figure 7-7 shows the denoised test images of our chosen category for different numbers of training epochs.

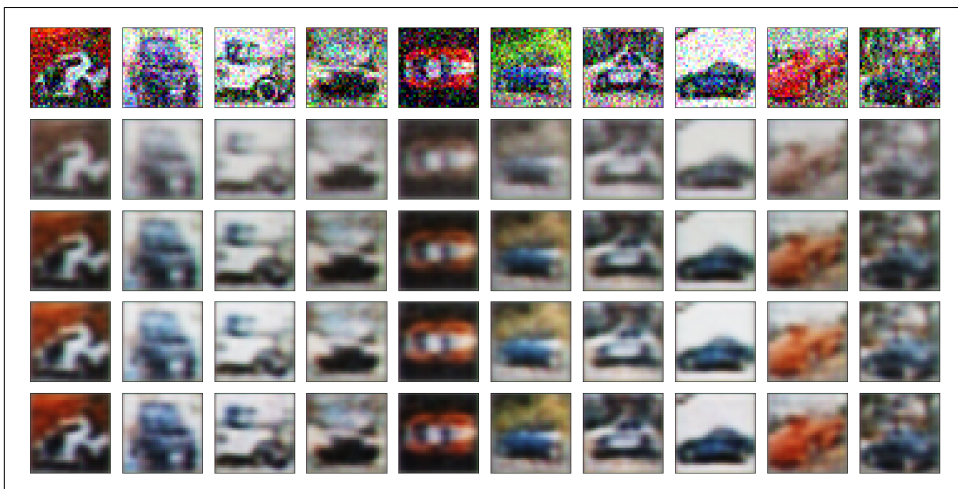

Figure 7-7. Noisy CIFAR10 images before autoencoding (upper row) and after autoencoding (lower rows). The 4 bottom rows show results after increasing number of training epochs.

Keras also has a bunch of pretrained models to download, like *inception*, *vgg*, and *resnet*. In the next and final section of this chapter, we will discuss these models and show an example of how to download and use a pretrained VGG model for classification using the TF-Slim extension.

## Pretrained models with TF-Slim

In this section of the chapter we will introduce the last abstraction to be covered here, TF-Slim. TF-Slim stands out by offering simplified syntax for defining convolutional neural networks in TensorFlow—its abstractions make it easy to build complex networks in a clean, streamlined manner. Like Keras, it also offers a nice variety of **pre-trained CNN models** to download and use.

We start this section by learning about some of the general features and benefits of TF-Slim, and why it's a great tool to use for building CNNs. In the second part of this section we will demonstrate how to download and deploy a pretrained model (VGG) for image classification.

## TF-Slim

TF-Slim is a relatively new lightweight extension of TensorFlow that, like other abstractions, allows us to define and train complex models quickly and intuitively. TF-Slim doesn't require any installation since it's been merged with TensorFlow.

This extension is all about convolutional neural networks. CNNs are notorious for having a lot of messy boilerplate code. TF-Slim was designed with the goal of optimizing the creation of very complex CNN models so that they could be elegantly written and easy to interpret and debug by using high-level layers, variable abstractions, and argument scoping, which we will touch upon shortly.

In addition to enabling us to create and train our own models, TF-Slim has available pretrained networks that can be easily downloaded, read, and used: VGG, AlexNet, Inception, and more.

We start this section by briefly describing some of TF-Slim's abstraction features. Then we shift our focus to how to download and use a pretrained model, demonstrating it for the VGG image classification model.

### Creating CNN models with TF-Slim

With TF-Slim we can create a variable easily by defining its initialization, regularization, and device with one wrapper. For example, here we define weights initialized from a truncated normal distribution using L2 regularization and placed on the CPU (we will talk about distributing model parts across devices in [Chapter 9](#)):

```
import tensorflow as tf
from tensorflow.contrib import slim

W = slim.variable('w', shape=[7, 7, 3, 3],
                  initializer=tf.truncated_normal_initializer(stddev=0.1),
                  regularizer=slim.l2_regularizer(0.07),
                  device='/CPU:0')
```

Like the other abstractions we've seen in this chapter, TF-Slim can reduce a lot of boilerplate code and redundant duplication. As with Keras or TFLearn, we can define a layer operation at an abstract level to include the convolution operation, weights initialization, regularization, activation function, and more in a single command:

```
net = slim.conv2d(inputs, 64, [11, 11], 4, padding='SAME',
                  weights_initializer=tf.truncated_normal_initializer(stddev=0.01),
                  weights_regularizer=slim.l2_regularizer(0.0007), scope='conv1')
```

TF-Slim extends its elegance even beyond that, providing a clean way to replicate layers compactly by using the `repeat`, `stack`, and `arg_scope` commands.



repeat saves us the need to copy and paste the same line over and over so that, for example, instead of having this redundant duplication:

```
net = slim.conv2d(net, 128, [3, 3], scope='con1_1')
net = slim.conv2d(net, 128, [3, 3], scope='con1_2')
net = slim.conv2d(net, 128, [3, 3], scope='con1_3')
net = slim.conv2d(net, 128, [3, 3], scope='con1_4')
net = slim.conv2d(net, 128, [3, 3], scope='con1_5')
```

we could just enter this:

```
net = slim.repeat(net, 5, slim.conv2d, 128, [3, 3], scope='con1')
```

But this is viable only in cases where we have layers of the same size. When this does not hold, we can use the stack command, allowing us to concatenate layers of different shapes. So, instead of this:

```
net = slim.conv2d(net, 64, [3, 3], scope='con1_1')
net = slim.conv2d(net, 64, [1, 1], scope='con1_2')
net = slim.conv2d(net, 128, [3, 3], scope='con1_3')
net = slim.conv2d(net, 128, [1, 1], scope='con1_4')
net = slim.conv2d(net, 256, [3, 3], scope='con1_5')
```

we can write this:

```
slim.stack(net, slim.conv2d, [(64, [3, 3]), (64, [1, 1]),
                             (128, [3, 3]), (128, [1, 1]),
                             (256, [3, 3])], scope='con')
```

Finally, we also have a scoping mechanism referred to as `arg_scope`, allowing users to pass a set of shared arguments to each operation defined in the same scope. Say, for example, that we have four layers having the same activation function, initialization, regularization, and padding. We can then simply use the `slim.arg_scope` command, where we specify the shared arguments as in the following code:

```
with slim.arg_scope([slim.conv2d],
                    padding='VALID',
                    activation_fn=tf.nn.relu,
                    weights_initializer=tf.truncated_normal_initializer(stddev=0.02)
                    weights_regularizer=slim.l2_regularizer(0.0007)):
    net = slim.conv2d(inputs, 64, [11, 11], scope='con1')
    net = slim.conv2d(net, 128, [11, 11], padding='VALID', scope='con2')
    net = slim.conv2d(net, 256, [11, 11], scope='con3')
    net = slim.conv2d(net, 256, [11, 11], scope='con4')
```

The individual arguments inside the `arg_scope` command can still be overwritten, and we can also nest one `arg_scope` inside another.

In these examples we used `conv2d()`: however, TF-Slim has many of the other standard methods for building neural networks. [Table 7-4](#) lists some of the available options. For the full list, consult [the documentation](#).

Table 7-4. Available layer types in TF-Slim

Layer	TF-Slim
BiasAdd	<code>slim.bias_add()</code>
BatchNorm	<code>slim.batch_norm()</code>
Conv2d	<code>slim.conv2d()</code>
Conv2dInPlane	<code>slim.conv2d_in_plane()</code>
Conv2dTranspose (Deconv)	<code>slim.conv2d_transpose()</code>
FullyConnected	<code>slim.fully_connected()</code>
AvgPool2D	<code>slim.avg_pool2d()</code>
Dropout	<code>slim.dropout()</code>
Flatten	<code>slim.flatten()</code>
MaxPool2D	<code>slim.max_pool2d()</code>
OneHotEncoding	<code>slim.one_hot_encoding()</code>
SeparableConv2	<code>slim.separable_conv2d()</code>
UnitNorm	<code>slim.unit_norm</code>

To illustrate how convenient TF-Slim is for creating complex CNNs, we will build the VGG model by Karen Simonyan and Andrew Zisserman that was introduced in 2014 (see the upcoming note for more information). VGG serves as a good illustration of how a model with many layers can be created compactly using TF-Slim. Here we construct the 16-layer version: 13 convolution layers plus 3 fully connected layers.

Creating it, we take advantage of two of the features we've just mentioned:

1. We use the `arg_scope` feature since all of the convolution layers have the same activation function and the same regularization and initialization.
2. Many of the layers are exact duplicates of others, and therefore we also take advantage of the `repeat` command.

The result very compelling—the entire model is defined with just 16 lines of code:

```
with slim.arg_scope([slim.conv2d, slim.fully_connected],
                    activation_fn=tf.nn.relu,
                    weights_initializer=tf.truncated_normal_initializer(0.0, 0.01),
                    weights_regularizer=slim.l2_regularizer(0.0005)):
    net = slim.repeat(inputs, 2, slim.conv2d, 64, [3, 3], scope='con1')
    net = slim.max_pool2d(net, [2, 2], scope='pool1')
    net = slim.repeat(net, 2, slim.conv2d, 128, [3, 3], scope='con2')
    net = slim.max_pool2d(net, [2, 2], scope='pool2')
    net = slim.repeat(net, 3, slim.conv2d, 256, [3, 3], scope='con3')
    net = slim.max_pool2d(net, [2, 2], scope='pool3')
    net = slim.repeat(net, 3, slim.conv2d, 512, [3, 3], scope='con4')
    net = slim.max_pool2d(net, [2, 2], scope='pool4')
    net = slim.repeat(net, 3, slim.conv2d, 512, [3, 3], scope='con5')
    net = slim.max_pool2d(net, [2, 2], scope='pool5')
    net = slim.fully_connected(net, 4096, scope='fc6')
```

```
net = slim.dropout(net, 0.5, scope='dropout6')
net = slim.fully_connected(net, 4096, scope='fc7')
net = slim.dropout(net, 0.5, scope='dropout7')
net = slim.fully_connected(net, 1000, activation_fn=None, scope='fc8')
```



## VGG and the ImageNet Challenge

The **ImageNet project** is a large database of images collected for the purpose of researching visual object recognition. As of 2016 it contained over 10 million hand-annotated images.

Each year (since 2010) a competition takes place called the ImageNet Large Scale Visual Recognition Challenge (ILSVRC), where research teams try to automatically classify, detect, and localize objects and scenes in a subset of the ImageNet collection. In the 2012 challenge, dramatic progress occurred when a deep convolutional neural net called AlexNet, created by Alex Krizhevsky, managed to get a top 5 (top 5 chosen categories) classification error of only 15.4%, winning the competition by a large margin.

Over the next couple of years the error rate kept falling, from ZFNet with 14.8% in 2013, to GoogLeNet (introducing the Inception module) with 6.7% in 2014, to ResNet with 3.6% in 2015. The Visual Geometry Group (VGG) was another CNN competitor in the 2014 competition that also achieved an impressive low error rate (7.3%). A lot of people prefer VGG over GoogLeNet because it has a nicer, simpler architecture.

In VGG the only spatial dimensions used are very small 3×3 filters with a stride of 1 and a 2×2 max pooling, again with a stride of 1. Its superiority is achieved by the number of layers it uses, which is between 16 and 19.

## Downloading and using a pretrained model

Next we will demonstrate how to download and deploy a pretrained VGG model.

First we need to clone the repository where the actual models will reside by running:

```
git clone https://github.com/tensorflow/models
```

Now we have the scripts we need for modeling on our computer, and we can use them by setting the path:

```
import sys
sys.path.append("<some_path> + models/slim")
```

Next we will download the pretrained VGG-16 (16 layers) model—it is available **on GitHub**, as are other models, such as Inception, ResNet, and more:

```

from datasets import dataset_utils
import tensorflow as tf
target_dir = '<some_path> + vgg/vgg_checkpoints'

```

The downloaded checkpoint file contains information about both the model and the variables. Now we want to load it and use it for classification of new images.

However, before that we first have to prepare our input image, turning it into a readable TensorFlow format and performing a little pre-processing to make sure that it is resized to match the size of the images the model was trained on.

We can load the image into TensorFlow either as a URL link or as a desktop image. For a URL link, we can load the image as a string with `urllib2` (this needs to be imported), and then decode it into a Tensor by using `tf.image_decode_jpeg()`:

```

import urllib2

url = ("https://somewebsite/somepicture.jpg")
im_as_string = urllib2.urlopen(url).read()
im = tf.image.decode_jpeg(im_as_string, channels=3)

```

Or, for PNG:

```

im = tf.image.decode_png(im_as_string, channels=3)

```

To load an image from our computer, we can create a queue of our filenames in the target directory, and then read the entire image file by using `tf.WholeFileReader()`:

```

filename_queue = tf.train.string_input_producer(
    tf.train.match_filenames_once("./images/*.jpg"))
image_reader = tf.WholeFileReader()
_, image_file = image_reader.read(filename_queue)
image = tf.image.decode_jpeg(image_file)

```

Don't worry about the details for this step; we will discuss queues and reading data in much more depth in [Chapter 8](#).

Next we want to resize the image so that it matches the size of the images VGG was trained on. For that, we first extract the desired size from the VGG script (in this case, it is 224):

```

from nets import vgg
image_size = vgg.vgg_16.default_image_size

```

Then we feed the raw image and the image size to the VGG pre-processing unit, where the image will be resized with a preserved aspect ratio (the width-to-height ratio of the image) and then cropped:

```

from preprocessing import vgg_preprocessing
processed_im = vgg_preprocessing.preprocess_image(image,
                                                    image_size,
                                                    image_size,
                                                    is_training=False)

```

Next we use `tf.expand_dims()` to insert a dimension of 1 into a tensor's shape. This is done to add a batch dimension to a single element (changing `[height, width, channels]` to `[1, height, width, channels]`):

```
processed_images = tf.expand_dims(processed_im, 0)
```

Now we create the model from the script we cloned earlier. We pass the model function the images and number of classes. The model has shared arguments; therefore, we call it using `arg_scope`, as we saw earlier, and use the `vgg_arg_scope()` function in the script to define the shared arguments. The function is shown in the following code snippet.

`vgg_16()` returns the logits (numeric values acting as evidence for each class), which we can then turn into probabilities by using `tf.nn.softmax()`. We use the argument `is_training` to indicate that we are interested in forming predictions rather than training:

```
with slim.arg_scope(vgg.vgg_arg_scope()):
    logits, _ = vgg.vgg_16(processed_images,
                           num_classes=1000,
                           is_training=False)
probabilities = tf.nn.softmax(logits)

def vgg_arg_scope(weight_decay=0.0005):
    with slim.arg_scope([slim.conv2d, slim.fully_connected],
                        activation_fn=tf.nn.relu,
                        weights_regularizer=slim.l2_regularizer(weight_decay),
                        biases_initializer=tf.zeros_initializer):
        with slim.arg_scope([slim.conv2d], padding='SAME') as arg_sc:
            return arg_sc
```

Now, just before starting the session, we need to load the variables we downloaded using `slim.assign_from_checkpoint_fn()`, to which we pass the containing directory:

```
import os

load_vars = slim.assign_from_checkpoint_fn(
    os.path.join(target_dir, 'vgg_16.ckpt'),
    slim.get_model_variables('vgg_16'))
```

Finally, the main event—we run the session, load the variables, and feed in the images and the desired probabilities.

We can get the class names by using the following lines:

```
from datasets import imagenet
imagenet.create_readable_names_for_imagenet_labels()
```

We extract the five classes with the highest probabilities for our given image, and the probabilities as well:

```

names = []
with tf.Session() as sess:
    load_vars(sess)
    network_input, probabilities = sess.run([processed_images,
                                             probabilities])

    probabilities = probabilities[0, 0:]
    names_ = imagenet.create_readable_names_for_imagenet_labels()
    idxs = np.argsort(-probabilities)[:5]
    probs = probabilities[idxs]
    classes = np.array(names_.values())[idxs+1]
    for c,p in zip(classes,probs):
        print('Class: ' + c + ' |Prob: ' + str(p))

```

In this example we passed the image shown in [Figure 7-8](#) as input to the pretrained VGG model.

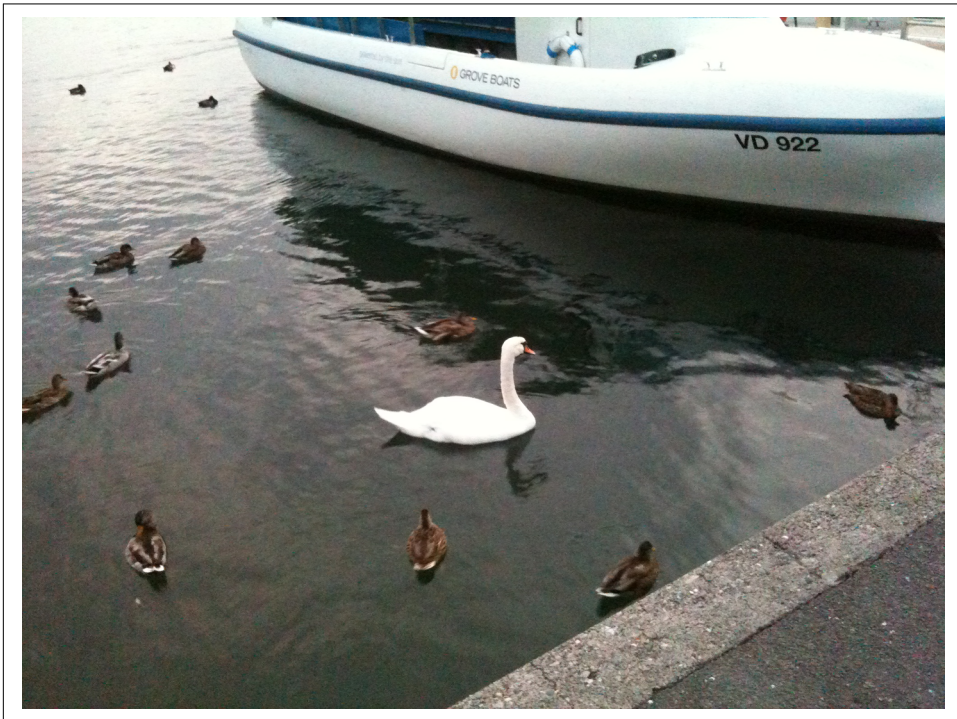

*Figure 7-8. A lakeside in Switzerland.*

Here are the output results for the top-five chosen classes and their probabilities:

```

Output:
Class: lakeside, lakeshore |Prob: 0.365693
Class: pelican |Prob: 0.163627
Class: dock, dockage, docking facility |Prob: 0.0608374
Class: breakwater, groin, groyne, mole, bulwark, seawall, jetty |Prob: 0.0393285
Class: speedboat |Prob: 0.0391587

```

As you can see, the classifier does quite well at capturing different elements in this image.

## Summary

We started this chapter by discussing the importance of abstractions, followed by high-level coverage and then focusing in on some of the popular TensorFlow extensions: `contrib.learn`, TFLearn, Keras, and TF-Slim. We revisited models from previous chapters, using out-of-the-box `contrib.learn` linear regression and linear classification models. We then saw how to use the `FeatureColumn` abstraction for feature handling and pre-processing, incorporate TensorBoard, and create our own custom estimator. We introduced TFLearn and exemplified how easily CNN and RNN models can be constructed with it. Using Keras, we demonstrated how to implement an autoencoder. Finally, we created complex CNN models with TF-Slim and deployed a pretrained model.

In the next chapters we cover scaling up, with queuing and threading, distributed computing, and model serving.





---

# Queues, Threads, and Reading Data

In this chapter we introduce the use of queues and threads in TensorFlow, with the main motivation of streamlining the process of reading input data. We show how to write and read TFRecords, the efficient TensorFlow file format. We then demonstrate queues, threads, and related functionalities, and connect all the dots in a full working example of a multithreaded input pipeline for image data that includes pre-processing, batching, and training.

## The Input Pipeline

When dealing with small datasets that can be stored in memory, such as MNIST images, it is reasonable to simply load all data into memory, then use feeding to push data into a TensorFlow graph. For larger datasets, however, this can become unwieldy. A natural paradigm for handling such cases is to keep the data on disk and load chunks of it as needed (such as mini-batches for training), such that the only limit is the size of your hard drive.

In addition, in many cases in practice, a typical data pipeline often includes steps such as reading input files with different formats, changing the shape or structure of input, normalizing or doing other forms of pre-processing, and shuffling the input, all before training has even started.

Much of this process can trivially be decoupled and broken into modular components. Pre-processing, for example, does not involve training, and thus naively inputs can be preprocessed all at once and then fed to training. Since our training works on batches of examples in any case, we could in principle handle batches of inputs on the fly, reading them from disk, applying pre-processing, and then feeding them into the computational graph for training.

This approach, however, can be wasteful. Because pre-processing is independent of training, waiting for each batch to be pre-processed would lead to severe I/O latency, forcing each training step to (impatiently) wait for mini-batches of data to be loaded and processed. A more scalable practice would be to prefetch the data and use independent threads for loading and processing and for training. But this practice, in turn, could become messy when working with many files kept on disk that need to be repeatedly read and shuffled, and require a fair amount of bookkeeping and technicalities to run seamlessly.

It's important to note that even without taking pre-processing into consideration, using the standard feeding mechanism (with a `feed_dict`) we saw in previous chapters is wasteful in itself. `feed_dict` does a single-threaded copy of data from the Python runtime to the TensorFlow runtime, causing further latency and slowdowns. We would like to avoid this by somehow reading data directly into native TensorFlow.

To make our lives easier (and faster), TensorFlow comes with a set of tools to streamline this input-pipeline process. The main building blocks are a standard TensorFlow file format, utilities for encoding and decoding this format, queues of data, and multithreading.

We will go over these key components one by one, exploring how they work and building toward an end-to-end multithreaded input pipeline. We begin by introducing TFRecords, the recommended file format for TensorFlow, which will come in useful later on.

## TFRecords

Datasets, of course, can come in many formats, sometimes even mixed (such as images and audio files). It can often be convenient—and useful—to convert input files into one unifying format, regardless of their original formats. TensorFlow's default, standard data format is the TFRecord. A TFRecord file is simply a binary file, containing serialized input data. Serialization is based on protocol buffers (*protobufs*), which in plain words convert data for storage by using a schema describing the data structure, independently of what platform or language is being used (much like XML).

In our setting, using TFRecords (and protobufs/binary files in general) has many advantages over just working with raw data files. This unified format allows for a tidy way to organize input data, with all relevant attributes for an input instance kept together, avoiding the need for many directories and subdirectories. TFRecord files enable very fast processing. All data is kept in one block of memory, as opposed to storing each input file separately, cutting the time needed to read data from memory. It's also important to note that TensorFlow comes with many implementations and

utilities optimized for TFRecords, making it well suited for use as part of a multi-threaded input pipeline.

## Writing with TFRecordWriter

We begin by writing our input files to TFRecord format, to allow us to work with them (in other cases, we may already have the data stored in this format). In this example we will convert MNIST images to this format, but the same ideas carry on to other types of data.

First, we download the MNIST data to `save_dir`, using a utility function from `tensorflow.contrib.learn`:

```
from __future__ import print_function
import os
import tensorflow as tf
from tensorflow.contrib.learn.python.learn.datasets import mnist

save_dir = "path/to/mnist"

# Download data to save_dir
data_sets = mnist.read_data_sets(save_dir,
                                  dtype=tf.uint8,
                                  reshape=False,
                                  validation_size=1000)
```

Our downloaded data includes train, test, and validation images, each in a separate *split*. We go over each split, putting examples in a suitable format and using `TFRecordWriter()` to write to disk:

```
data_splits = ["train", "test", "validation"]
for d in range(len(data_splits)):
    print("saving " + data_splits[d])
    data_set = data_sets[d]

    filename = os.path.join(save_dir, data_splits[d] + '.tfrecords')
    writer = tf.python_io.TFRecordWriter(filename)
    for index in range(data_set.images.shape[0]):
        image = data_set.images[index].tostring()
        example = tf.train.Example(features=tf.train.Features(feature=[
            'height': tf.train.Feature(int64_list=
                tf.train.Int64List(value=
                    [data_set.images.shape[1]])),
            'width': tf.train.Feature(int64_list=
                tf.train.Int64List(value =
                    [data_set.images.shape[2]])),
            'depth': tf.train.Feature(int64_list=
                tf.train.Int64List(value =
                    [data_set.images.shape[3]])),
            'label': tf.train.Feature(int64_list=
                tf.train.Int64List(value =
```

```

        [int(data_set.labels[index]))]),
    'image_raw': tf.train.Feature(bytes_list=
        tf.train.BytesList(value =
            [image]))))
    writer.write(example.SerializeToString())
writer.close()

```

Let's break this code down to understand the different components.

We first instantiate a `TFRecordWriter` object, giving it the path corresponding to the data split:

```

filename = os.path.join(save_dir, data_splits[d] + '.tfrecords')
writer = tf.python_io.TFRecordWriter(filename)

```

We then go over each image, converting it from a NumPy array to a byte string:

```

image = data_set.images[index].tostring()

```

Next, we convert images to their protobuf format. `tf.train.Example` is a structure for storing our data. An `Example` object contains a `Features` object, which in turn contains a map from attribute name to a `Feature`. A `Feature` can contain an `Int64List`, a `BytesList`, or a `FloatList` (not used here). For example, here we encode the label of the image:

```

tf.train.Feature(int64_list=tf.train.Int64List(value =
    [int(data_set.labels[index]))])

```

And here is the encoding for the actual raw image:

```

tf.train.Feature(bytes_list=tf.train.BytesList(value =[image]))

```

Let's take a look at what our saved data looks like. We do this with `tf.python_io.tf_record_iterator`, an iterator that reads records from a `TFRecords` file:

```

filename = os.path.join(save_dir, 'train.tfrecords')
record_iterator = tf.python_io.tf_record_iterator(filename)
serialized_img_example= next(record_iterator)

```

`serialized_img` is a byte string. To recover the structure we used when saving the image to a `TFRecord`, we parse this byte string, allowing us to access all the attributes we stored earlier:

```

example = tf.train.Example()
example.ParseFromString(serialized_img_example)
image = example.features.feature['image_raw'].bytes_list.value
label = example.features.feature['label'].int64_list.value[0]
width = example.features.feature['width'].int64_list.value[0]
height = example.features.feature['height'].int64_list.value[0]

```

Our image was saved as a byte string too, so we convert it back to a NumPy array and reshape it back to a tensor with shape (28,28,1):

```
img_flat = np.fromstring(image[0], dtype=np.uint8)
img_reshaped = img_flat.reshape((height, width, -1))
```

This basic example should have given you a feel for TFRecords and how to write and read them. In practice, we will typically want to read TFRecords into a queue of pre-fetched data as part of a multithreaded process. In the next section, we first introduce TensorFlow queues before showing how to use them with TFRecords.

## Queues

A TensorFlow queue is similar to an ordinary queue, allowing us to enqueue new items, dequeue existing items, etc. The important difference from ordinary queues is that, just like anything else in TensorFlow, the queue is part of a computational graph. Its operations are symbolic as usual, and other nodes in the graph can alter its state (much like with Variables). This can be slightly confusing at first, so let's walk through some examples to get acquainted with basic queue functionalities.

### Enqueuing and Dequeuing

Here we create a *first-in, first-out* (FIFO) queue of strings, with a maximal number of 10 elements that can be stored in the queue. Since queues are part of a computational graph, they are run within a session. In this example, we use a `tf.InteractiveSession()`:

```
import tensorflow as tf

sess= tf.InteractiveSession()
queue1 = tf.FIFOQueue(capacity=10,dtypes=[tf.string])
```

Behind the scenes, TensorFlow creates a memory buffer for storing the 10 items.

Just like any other operation in TensorFlow, to add items to the queue, we create an op:

```
enqueue_op = queue1.enqueue(["F"])
```

Since you are by now familiar with the concept of a computational graph in TensorFlow, it should be no surprise that defining the `enqueue_op` does not add anything to the queue—we need to run the op. So, if we look at the size of `queue1` before running the op, we get this:

```
sess.run(queue1.size())
```

```
Out:
0
```

After running the op, our queue now has one item populating it:

```
enqueue_op.run()
sess.run(queue1.size())
```

```
Out:  
1
```

Let's add some more items to `queue1`, and look at its size again:

```
enqueue_op = queue1.enqueue(["I"])  
enqueue_op.run()  
enqueue_op = queue1.enqueue(["F"])  
enqueue_op.run()  
enqueue_op = queue1.enqueue(["O"])  
enqueue_op.run()  
  
sess.run(queue1.size())
```

```
Out:  
4
```

Next, we dequeue items. Dequeueing too is an op, whose output evaluates to a tensor corresponding to the dequeued item:

```
x = queue1.dequeue()  
x.eval()
```

```
Out: b'F'  
x.eval()
```

```
Out: b'I'  
x.eval()
```

```
Out: b'F'  
x.eval()
```

```
Out: b'O'
```

Note that if we were to run `xs.eval()` one more time, on an empty queue, our main thread would hang forever. As we will see later in this chapter, in practice we use code that knows when to stop dequeuing and avoid hanging.

Another way to dequeue is by retrieving multiple items at once, with the `dequeue_many()` operation. This op requires that we specify the shape of items in advance:

```
queue1 = tf.FIFOQueue(capacity=10, dtypes=[tf.string], shapes=[()])
```

Here we fill the queue exactly as before, and then dequeue four items at once:

```
inputs = queue1.dequeue_many(4)  
inputs.eval()  
  
Out:  
array([b'F', b'I', b'F', b'O'], dtype=object)
```

## Multithreading

A TensorFlow session is multithreaded—multiple threads can use the same session and run ops in parallel. Individual ops have parallel implementations that are used by default with multiple CPU cores or GPU threads. However, if a single call to `sess.run()` does not make full use of the available resources, one can increase throughput by making multiple parallel calls. For example, in a typical scenario, we may have multiple threads apply pre-processing to images and push them into a queue, while another thread pulls pre-processed images from the queue for training (in the next chapter, we will discuss distributed training, which is conceptually related, with important differences).

Let's walk our way through a few simple examples introducing threading in TensorFlow and the natural interplay with queues, before connecting all the dots later on in a full example with MNIST images.

We start by creating a FIFO queue with capacity of 100 items, where each item is a random float generated with `tf.random_normal()`:

```
from __future__ import print_function
import threading
import time

gen_random_normal = tf.random_normal(shape=())
queue = tf.FIFOQueue(capacity=100, dtypes=[tf.float32], shapes=())
enqueue = queue.enqueue(gen_random_normal)

def add():
    for i in range(10):
        sess.run(enqueue)
```

Note, again, that the enqueue op does not actually add the random numbers to the queue (and they are not yet generated) prior to graph execution. Items will be enqueued using the function `add()` we create that adds 10 items to the queue by calling `sess.run()` multiple times.

Next, we create 10 threads, each running `add()` in parallel, thus each pushing 10 items to the queue, asynchronously. We could think (for now) of these random numbers as training data being added into a queue:

```
threads = [threading.Thread(target=add, args=()) for i in range(10)]
```

```
threads
```

```
Out:
```

```
[<Thread(Thread-77, initial)>,  
<Thread(Thread-78, initial)>,  
<Thread(Thread-79, initial)>,  
<Thread(Thread-80, initial)>,  
<Thread(Thread-81, initial)>,  
<Thread(Thread-82, initial)>,  
<Thread(Thread-83, initial)>,  
<Thread(Thread-84, initial)>,  
<Thread(Thread-85, initial)>,  
<Thread(Thread-86, initial)>]
```

We have created a list of threads, and now we execute them, printing the size of the queue at short intervals as it grows from 0 to 100:

```
for t in threads:  
    t.start()  
  
print(sess.run(queue.size()))  
time.sleep(0.01)  
print(sess.run(queue.size()))  
time.sleep(0.01)  
print(sess.run(queue.size()))
```

```
Out:
```

```
10  
84  
100
```

Finally, we dequeue 10 items at once with `dequeue_many()`, and examine the results:

```
x = queue.dequeue_many(10)  
print(x.eval())  
sess.run(queue.size())
```

```
Out:
```

```
[ 0.05863889  0.61680967  1.05087686 -0.29185265 -0.44238046  0.53796548  
 -0.24784896  0.40672767 -0.88107938  0.24592835]  
90
```

## Coordinator and QueueRunner

In realistic scenarios (as we shall see later in this chapter), it can be more complicated to run multiple threads effectively. Threads should be able to stop properly (to avoid “zombie” threads, for example, or to close all threads together when one fails), queues need to be closed after stopping, and there are other technical but important issues that need to be addressed.



TensorFlow comes equipped with tools to help us in this process. Key among them are `tf.train.Coordinator`, for coordinating the termination of a set of threads, and `tf.train.QueueRunner`, which streamlines the process of getting multiple threads to enqueue data with seamless cooperation.

## `tf.train.Coordinator`

We first demonstrate how to use `tf.train.Coordinator` with a simple, toy example. In the next section, we'll see how to use it as part of a real input pipeline.

We use the code similar to that in the previous section, altering the `add()` function and adding a coordinator:

```
gen_random_normal = tf.random_normal(shape=())
queue = tf.FIFOQueue(capacity=100, dtypes=[tf.float32], shapes=())
enqueue = queue.enqueue(gen_random_normal)

def add(coord, i):
    while not coord.should_stop():
        sess.run(enqueue)
        if i == 11:
            coord.request_stop()

coord = tf.train.Coordinator()
threads = [threading.Thread(target=add, args=(coord, i)) for i in range(10)]
coord.join(threads)

for t in threads:
    t.start()

print(sess.run(queue.size()))
time.sleep(0.01)
print(sess.run(queue.size()))
time.sleep(0.01)
print(sess.run(queue.size()))

10
100
100
```

Any thread can call `coord.request_stop()` to get all other threads to stop. Threads typically run loops that check whether to stop, using `coord.should_stop()`. Here, we pass the thread index `i` to `add()`, and use a condition that is never satisfied (`i==11`) to request a stop. Thus, our threads complete their job, adding the full 100 items to the queue. However, if we were to alter `add()` as follows:

```
def add(coord, i):
    while not coord.should_stop():
        sess.run(enqueue)
        if i == 1:
            coord.request_stop()
```

then thread `i=1` would use the coordinator to request all threads to stop, stopping all enqueueing early:

```
print(sess.run(queue.size()))
time.sleep(0.01)
print(sess.run(queue.size()))
time.sleep(0.01)
print(sess.run(queue.size()))
```

```
Out:
10
17
17
```

## `tf.train.QueueRunner` and `tf.RandomShuffleQueue`

While we can create a number of threads that repeatedly run an enqueue op, it is better practice to use the built-in `tf.train.QueueRunner`, which does exactly that, while closing the queue upon an exception.

Here we create a queue runner that will run four threads in parallel to enqueue items:

```
gen_random_normal = tf.random_normal(shape=())
queue = tf.RandomShuffleQueue(capacity=100, dtypes=[tf.float32],
                             min_after_dequeue=1)
enqueue_op = queue.enqueue(gen_random_normal)

qr = tf.train.QueueRunner(queue, [enqueue_op] * 4)
coord = tf.train.Coordinator()
enqueue_threads = qr.create_threads(sess, coord=coord, start=True)
coord.request_stop()
coord.join(enqueue_threads)
```

Note that `qr.create_threads()` takes our session as an argument, along with our coordinator.

In this example, we used a `tf.RandomShuffleQueue` rather than the FIFO queue. A `RandomShuffleQueue` is simply a queue with a dequeue op that pops items in random order. This is useful when training deep neural networks with stochastic gradient-descent optimization, which requires shuffling the data. The `min_after_dequeue` argument specifies the minimum number of items that will remain in the queue after calling a dequeue op—a bigger number entails better mixing (random sampling), but more memory.

## A Full Multithreaded Input Pipeline

We now put all the pieces together in a working example with MNIST images, from writing data to TensorFlow's efficient file format, through data loading and pre-processing, to training a model. We do so by building on the queuing and multi-

threading functionality demonstrated earlier, and along the way introduce some more useful components for reading and processing data in TensorFlow.

First, we write the MNIST data to TFRecords, with the same code we used at the start of this chapter:

```
from __future__ import print_function
import os
import tensorflow as tf
from tensorflow.contrib.learn.python.learn.datasets import mnist
import numpy as np

save_dir = "path/to/mnist"

# Download data to save_dir
data_sets = mnist.read_data_sets(save_dir,
                                  dtype=tf.uint8,
                                  reshape=False,
                                  validation_size=1000)

data_splits = ["train", "test", "validation"]
for d in range(len(data_splits)):
    print("saving " + data_splits[d])
    data_set = data_sets[d]

    filename = os.path.join(save_dir, data_splits[d] + '.tfrecords')
    writer = tf.python_io.TFRecordWriter(filename)
    for index in range(data_set.images.shape[0]):
        image = data_set.images[index].tostring()
        example = tf.train.Example(features=tf.train.Features(feature={
            'height': tf.train.Feature(int64_list=
                tf.train.Int64List(value=
                    [data_set.images.shape[1]])),
            'width': tf.train.Feature(int64_list=
                tf.train.Int64List(value =
                    [data_set.images.shape[2]])),
            'depth': tf.train.Feature(int64_list=
                tf.train.Int64List(value =
                    [data_set.images.shape[3]])),
            'label': tf.train.Feature(int64_list=
                tf.train.Int64List(value =
                    [int(data_set.labels[index])])),
            'image_raw': tf.train.Feature(bytes_list=
                tf.train.BytesList(value =
                    [image]))}))

        writer.write(example.SerializeToString())
    writer.close()
```

## tf.train.string\_input\_producer() and tf.TFRecordReader()

`tf.train.string_input_producer()` simply creates a `QueueRunner` behind the scenes, outputting filename strings to a queue for our input pipeline. This filename queue will be shared among multiple threads:

```
filename = os.path.join(save_dir, "train.tfrecords")
filename_queue = tf.train.string_input_producer(
    [filename], num_epochs=10)
```

The `num_epochs` argument tells `string_input_producer()` to produce each filename string `num_epochs` times.

Next, we read files from this queue using `TFRecordReader()`, which takes a queue of filenames and dequeues filename by filename off the `filename_queue`. Internally, `TFRecordReader()` uses the state of the graph to keep track of the location of the `TFRecord` being read, as it loads “chunk after chunk” of input data from the disk:

```
reader = tf.TFRecordReader()
_, serialized_example = reader.read(filename_queue)
features = tf.parse_single_example(
    serialized_example,
    features={
        'image_raw': tf.FixedLenFeature([], tf.string),
        'label': tf.FixedLenFeature([], tf.int64),
    })
```

## tf.train.shuffle\_batch()

We decode the raw byte string data, do (very) basic pre-processing to convert pixel values to floats, and then shuffle the image instances and collect them into `batch_size` batches with `tf.train.shuffle_batch()`, which internally uses a `RandomShuffleQueue` and accumulates examples until it contains `batch_size + min_after_dequeue` elements:

```
image = tf.decode_raw(features['image_raw'], tf.uint8)
image.set_shape([784])
image = tf.cast(image, tf.float32) * (1. / 255) - 0.5
label = tf.cast(features['label'], tf.int32)
# Randomly collect instances into batches
images_batch, labels_batch = tf.train.shuffle_batch(
    [image, label], batch_size=128,
    capacity=2000,
    min_after_dequeue=1000)
```

The `capacity` and `min_after_dequeue` parameters are used in the same manner as discussed previously. The mini-batches that are returned by `shuffle_batch()` are the result of a `dequeue_many()` call on the `RandomShuffleQueue` that is created internally.

## tf.train.start\_queue\_runners() and Wrapping Up

We define our simple softmax classification model as follows:

```
W = tf.get_variable("W", [28*28, 10])
y_pred = tf.matmul(images_batch, W)
loss = tf.nn.sparse_softmax_cross_entropy_with_logits(logits=y_pred,
                                                    labels=labels_batch)

loss_mean = tf.reduce_mean(loss)

train_op = tf.train.AdamOptimizer().minimize(loss)

sess = tf.Session()
init = tf.global_variables_initializer()
sess.run(init)
init = tf.local_variables_initializer()
sess.run(init)
```

Finally, we create threads that enqueue data to queues by calling `tf.train.start_queue_runners()`. Unlike other calls, this one is not symbolic and actually creates the threads (and thus needs to be done after initialization):

```
from __future__ import print_function

# Coordinator
coord = tf.train.Coordinator()
threads = tf.train.start_queue_runners(sess=sess, coord=coord)
```

Let's take a look at the list of created threads:

```
threads

Out:
[<Thread(Thread-483, stopped daemon 13696)>,
 <Thread(Thread-484, started daemon 16376)>,
 <Thread(Thread-485, started daemon 4320)>,
 <Thread(Thread-486, started daemon 13052)>,
 <Thread(Thread-487, started daemon 7216)>,
 <Thread(Thread-488, started daemon 4332)>,
 <Thread(Thread-489, started daemon 16820)>]
```

Having everything in place, we are now ready to run the multithreaded process, from reading and pre-processing batches into a queue to training a model. It's important to note that we do not use the familiar `feed_dict` argument anymore—this avoids data copies and offers speedups, as discussed earlier in this chapter:

```

try:
    step = 0
    while not coord.should_stop():
        step += 1
        sess.run([train_op])
        if step%500==0:
            loss_mean_val = sess.run([loss_mean])
            print(step)
            print(loss_mean_val)
except tf.errors.OutOfRangeError:
    print('Done training for %d epochs, %d steps.' % (NUM_EPOCHS, step))
finally:
    # When done, ask the threads to stop
    coord.request_stop()

# Wait for threads to finish
coord.join(threads)
sess.close()

```

We train until a `tf.errors.OutOfRangeError` error is thrown, indicating that queues are empty and we are done:

```

Out:
Done training for 10 epochs, 2299500 steps.

```



### Future input pipeline

In mid-2017, the TensorFlow development team announced the Dataset API, a new preliminary input pipeline abstraction offering some simplifications and speedups. The concepts presented in this chapter, such as TFRecords and queues, are fundamental and remain at the core of TensorFlow and its input pipeline process. TensorFlow is still very much a work in progress, and exciting and important changes naturally occur from time to time. See [the issue tracker](#) for an ongoing discussion.

## Summary

In this chapter, we saw how to use queues and threads in TensorFlow, and how to create a multithreaded input pipeline. This process can help increase throughput and utilization of resources. In the next chapter, we take this a step forward and show how to work in a distributed setting with TensorFlow, across multiple devices and machines.

---

# Distributed TensorFlow

In this chapter we discuss the use of TensorFlow for distributed computing. We start by briefly surveying the different approaches to distributing model training in machine learning in general, and specifically for deep learning. We then introduce the elements of TensorFlow designed to support distributed computing, and finally put everything together with an end-to-end example.

## Distributed Computing

*Distributed computing*, in the most general terms, entails the utilization of more than one component in order to perform the desired computation or achieve a goal. In our case, this means using multiple machines in order to speed up the training of a deep learning model.

The basic idea behind this is that by using more computing power, we should be able to train the same model faster. This is indeed often the case, although just how much faster depends on many factors (i.e., if you expect to use 10× resources and get a 10× speedup, you are most likely going to be disappointed!).

There are many ways to distribute computations in a machine learning setting. You may want to utilize multiple devices, either on the same machine or across a cluster. When training a single model, you may want to compute gradients across a cluster to speed up training, either synchronously or asynchronously. A cluster may also be used to train multiple models at the same time, or in order to search for the optimal parameters for a single model.

In the following subsections we map out these many aspects of parallelism.

## Where Does the Parallelization Take Place?

The first split in the classification of types of parallelization is the location. Are we using multiple computing devices on a single machine or across a cluster?

It is becoming increasingly common to have powerful hardware with multiple devices on a single machine. Cloud providers (such as Amazon Web Services) now offer this sort of platform set up and ready to go.

Whether in the cloud or on premises, a cluster configuration affords more flexibility in design and evolution, and the setup can grow way beyond what is currently feasible with multiple devices on the same board (essentially, you can use a cluster of arbitrary size).

On the other hand, while several devices on the same board can use shared memory, the cluster approach introduces the time cost of communication between nodes. This can become a limiting factor, when the amount of information that has to be shared is large and communication is relatively slow.

## What Is the Goal of Parallelization?

The second split is the actual goal. Do we want to use more hardware to make the same process faster, or in order to parallelize the training of multiple models?

The need to train multiple models often arises in development stages where a choice needs to be made regarding either the models or the hyperparameters to use. In this case it is common to run several options and choose the best-performing one. It is natural to do so in parallel.

Alternatively, when training a single (often large) model, a cluster may be used in order to speed up training. In the most common approach, known as *data parallelism*, the same model structure exists on each computation device separately, and the data running through each copy is what is parallelized.

For example, when training a deep learning model with gradient descent, the process is composed of the following steps:

1. Compute the gradients for a batch of training examples.
2. Sum the gradients.
3. Apply an update to the model parameters accordingly.

Clearly, step 1 of this schema lends itself to parallelization. Simply use multiple devices to compute the gradients (with respect to different training examples), and then aggregate the results and sum them up in step 2, just as in the regular case.





## Synchronous versus asynchronous data parallelism

In the process just described, gradients from different training examples are aggregated together, in order to make a single update to the model parameters. This is what is known as *synchronous* training, since the summation step defines a point where the flow has to wait for all of the nodes to complete the gradient computation.

One case where it might be better to avoid this is when there are heterogeneous computing resources being used together, since the synchronous option entails waiting for the slowest of the nodes.

The alternative, *asynchronous* option is to apply the update step independently after each node finishes computing the gradients for the training examples it was assigned.

## TensorFlow Elements

In this section we go over the TensorFlow elements and concepts that are used in parallel computations. This is not a complete overview, and primarily serves as an introduction to the parallel example that concludes this chapter.

### tf.app.flags

We start with a mechanism that is completely unrelated to parallel computing, but is essential for our example at the end of the chapter. Indeed, the `flags` mechanism is heavily used in TensorFlow examples and deserves to be discussed.

Essentially, `tf.app.flags` is a wrapper for the Python `argparse` module, which is commonly used to process command-line arguments, with some extra and specific functionality.

Consider, for instance, a Python command-line program with typical command-line arguments:

```
'python distribute.py --job_name="ps" --task_index=0'
```

The program `distribute.py` is passed the following:

```
job_name="ps"  
task_index=0
```

This information is then extracted within the Python script, by using:

```
tf.app.flags.DEFINE_string("job_name", "", "name of job")  
tf.app.flags.DEFINE_integer("task_index", 0, "Index of task")
```

The arguments (both string and integer) are defined by the name in the command line, a default value, and a description of the argument.

The flags mechanism allows the following types of arguments:

- `tf.app.flags.DEFINE_string` defines a string value.
- `tf.app.flags.DEFINE_boolean` defines a Boolean value.
- `tf.app.flags.DEFINE_float` defines a floating-point value.
- `tf.app.flags.DEFINE_integer` defines an integer value.

Finally, `tf.app.flags.FLAGS` is a structure containing the values of all the arguments parsed from the command-line input. The arguments are accessed as `FLAGS.arg`, or via the dictionary `FLAGS.__flags` if necessary (it is, however, highly recommended to use the first option—the way it was designed to be used).

## Clusters and Servers

A TensorFlow cluster is simply a set of nodes (a.k.a. tasks) that participate in parallel processing of a computation graph. Each task is defined by the network address at which it may be accessed. For example:

```
parameter_servers = ["localhost:2222"]
workers = ["localhost:2223",
           "localhost:2224",
           "localhost:2225"]
cluster = tf.train.ClusterSpec({"parameter_server": parameter_servers,
                               "worker": workers})
```

Here we defined four local tasks (note that `localhost:XXXX` points to port `XXXX` on the current machine, and in a multiple-computer setting the `localhost` would be replaced by an IP address). The tasks are divided into a single *parameter server* and three *workers*. The parameter server/worker assignments are referred to as *jobs*. We further describe what each of these does during training later on in the chapter.

Each of the tasks must run a TensorFlow server, in order to both use local resources for the actual computations and communicate with other tasks in the cluster to facilitate parallelization.

Building on the cluster definition, a server on the first worker node (i.e., `localhost:2223`) would be started by:

```
server = tf.train.Server(cluster,
                        job_name="worker",
                        task_index=0)
```

The arguments received by `Server()` let it know its identity, as well as the identities and addresses of the other members in the cluster.

Once we have the clusters and servers in place, we build the computation graph that will allow us to go forward with the parallel computation.

## Replicating a Computational Graph Across Devices

As mentioned previously, there is more than one way to perform parallel training. In “[Device Placement](#)” on page 172, we briefly discuss how to directly place operations on a specific task in a cluster. In the rest of this section we go over what is necessary for between-graph replication.

*Between-graph replication* refers to the common parallelization mode where a separate but identical computation graph is built on each of the worker tasks. During training, gradients are computed by each of the workers and combined by the parameter server, which also keeps track of the current versions of the parameters, and possibly other global elements of training (such as a global step counter, etc.).

We use `tf.train.replica_device_setter()` in order to replicate the model (computation graph) on each of the tasks. The `worker_device` argument should point to the current task within the cluster. For instance, on the first worker we run this:

```
with tf.device(tf.train.replica_device_setter(
    worker_device="/job:worker/task:%d" % 0,
    cluster=cluster)):

    # Build model...
```

The exception is the parameter server, on which we don't build a computation graph. In order for the process not to terminate, we use:

```
server.join()
```

which will keep the parameter server alive for the duration of the parallel computation.

## Managed Sessions

In this section we cover the mechanism that we will later use for parallel training of our model. First, we define a `Supervisor`:

```
sv = tf.train.Supervisor(is_chief=...,
                        logdir=...,
                        global_step=...,
                        init_op=...)
```

As the name suggests, the `Supervisor` is used to supervise training, providing some utilities necessary for the parallel setting.

There are four arguments passed:

`is_chief` (*Boolean*)

There must be a single *chief*, which is the task responsible for initialization, etc.

`logdir` (*string*)

Where to store logs.

`global_step`

A TensorFlow Variable that will hold the current global step during training.

`init_op`

A TensorFlow op for initializing the model, such as `tf.global_variables_initializer()`.

The actual session is then launched:

```
with sv.managed_session(server.target) as sess:
    # Train ...
```

At this point the chief will initialize variables, while all other tasks wait for this to be completed.

## Device Placement

The final TensorFlow mechanism we discuss in this section is *device placement*. While the full extent of this topic is outside the scope of this chapter, the overview would not be complete without a mention of this ability, which is mostly useful when engineering advanced systems.

When operating in an environment with multiple computational devices (CPUs, GPUs, or any combination of these), it may be useful to control where each operation in the computational graph is going to take place. This may be done to better utilize parallelism, exploit the different capabilities of different devices, and overcome limitations such as memory limits on some devices.

Even when you do not explicitly choose device placement, TensorFlow will output the placement used if required to. This is enabled while constructing the session:

```
tf.Session(config=tf.ConfigProto(log_device_placement=True))
```

In order to explicitly choose a device, we use:

```
with tf.device('/gpu:0'):
    op = ...
```

The `'/gpu:0'` points TensorFlow to the first GPU on the system; likewise, we could have used `'/cpu:0'` to place the op on the CPUs, or `'/gpu:X'` on a system with multiple GPU devices, where `X` is the index of the GPU we would like to use.

Finally, placement across a cluster is done by pointing to the specific task. For instance:

```
with tf.device("/job:worker/task:2"):
    op = ...
```

This will assign to the second worker task, as defined in the cluster specification.



### Placement across CPUs

By default, TensorFlow uses all the CPUs available on the system and handles the threading internally. For this reason, the device placement `'/cpu:0'` is the full CPU power, and `'/cpu:1'` doesn't exist by default, even in a multiple-CPU environment.

In order to manually assign to specific CPUs (which you would need a very good reason to do—otherwise, let TensorFlow handle it), a session has to be defined with the directive to separate the CPUs:

```
config = tf.ConfigProto(device_count={"CPU": 8},
                        inter_op_parallelism_threads=8,
                        intra_op_parallelism_threads=1)
sess = tf.Session(config=config)
```

Here, we define two parameters:

- `inter_op_parallelism_threads=8`, meaning we allow eight threads for different ops
- `intra_op_parallelism_threads=1`, indicating that each op gets a single thread

These settings would make sense for an 8-CPU system.

## Distributed Example

In this section we put it all together with an end-to-end example of distributed training of the MNIST CNN model we saw in [Chapter 4](#). We will use one parameter server and three worker tasks. In order to make it easily reproducible, we will assume all the tasks are running locally on a single machine (this is easily adapted to a multiple-machine setting by replacing `localhost` with the IP address, as described earlier). As usual, we first present the full code, and then break it down into elements and explain it:

```
import tensorflow as tf
from tensorflow.contrib import slim
from tensorflow.examples.tutorials.mnist import input_data

BATCH_SIZE = 50
TRAINING_STEPS = 5000
PRINT_EVERY = 100
LOG_DIR = "/tmp/log"
```

```

parameter_servers = ["localhost:2222"]
workers = ["localhost:2223",
           "localhost:2224",
           "localhost:2225"]

cluster = tf.train.ClusterSpec({"ps": parameter_servers, "worker": workers})

tf.app.flags.DEFINE_string("job_name", "", "'ps' / 'worker'")
tf.app.flags.DEFINE_integer("task_index", 0, "Index of task")
FLAGS = tf.app.flags.FLAGS

server = tf.train.Server(cluster,
                        job_name=FLAGS.job_name,
                        task_index=FLAGS.task_index)

mnist = input_data.read_data_sets('MNIST_data', one_hot=True)

def net(x):
    x_image = tf.reshape(x, [-1, 28, 28, 1])
    net = slim.layers.conv2d(x_image, 32, [5, 5], scope='conv1')
    net = slim.layers.max_pool2d(net, [2, 2], scope='pool1')
    net = slim.layers.conv2d(net, 64, [5, 5], scope='conv2')
    net = slim.layers.max_pool2d(net, [2, 2], scope='pool2')
    net = slim.layers.flatten(net, scope='flatten')
    net = slim.layers.fully_connected(net, 500, scope='fully_connected')
    net = slim.layers.fully_connected(net, 10, activation_fn=None,
                                       scope='pred')

    return net

if FLAGS.job_name == "ps":
    server.join()

elif FLAGS.job_name == "worker":

    with tf.device(tf.train.replica_device_setter(
        worker_device="/job:worker/task:%d" % FLAGS.task_index,
        cluster=cluster)):

        global_step = tf.get_variable('global_step', [],
                                       initializer=tf.constant_initializer(0),
                                       trainable=False)

        x = tf.placeholder(tf.float32, shape=[None, 784], name="x-input")
        y_ = tf.placeholder(tf.float32, shape=[None, 10], name="y-input")
        y = net(x)

        cross_entropy = tf.reduce_mean(

```

```

        tf.nn.softmax_cross_entropy_with_logits(y, y_))
train_step = tf.train.AdamOptimizer(1e-4)\
    .minimize(cross_entropy, global_step=global_step)

correct_prediction = tf.equal(tf.argmax(y, 1), tf.argmax(y_, 1))
accuracy = tf.reduce_mean(tf.cast(correct_prediction, tf.float32))

init_op = tf.global_variables_initializer()

sv = tf.train.Supervisor(is_chief=(FLAGS.task_index == 0),
                        logdir=LOG_DIR,
                        global_step=global_step,
                        init_op=init_op)

with sv.managed_session(server.target) as sess:
    step = 0

    while not sv.should_stop() and step <= TRAINING_STEPS:

        batch_x, batch_y = mnist.train.next_batch(BATCH_SIZE)

        _, acc, step = sess.run([train_step, accuracy, global_step],
                                feed_dict={x: batch_x, y_: batch_y})

        if step % PRINT_EVERY == 0:
            print "Worker : {}, Step: {}, Accuracy (batch): {}".format(
                FLAGS.task_index, step, acc)

        test_acc = sess.run(accuracy, feed_dict={x: mnist.test.images,
                                                y_: mnist.test.labels})
        print "Test-Accuracy: {}".format(test_acc)

sv.stop()

```

In order to run this distributed example, from four different terminals we execute the four commands for dispatching each of the tasks (we will shortly explain how exactly this happens):

```

python distribute.py --job_name="ps" --task_index=0
python distribute.py --job_name="worker" --task_index=0
python distribute.py --job_name="worker" --task_index=1
python distribute.py --job_name="worker" --task_index=2

```

Alternatively, the following will dispatch the four tasks automatically (depending on the system you are using, the output may all go to a single terminal or to four separate ones):

```

import subprocess
subprocess.Popen('python distribute.py --job_name="ps" --task_index=0',
                 shell=True)
subprocess.Popen('python distribute.py --job_name="worker" --task_index=0',
                 shell=True)
subprocess.Popen('python distribute.py --job_name="worker" --task_index=1',
                 shell=True)
subprocess.Popen('python distribute.py --job_name="worker" --task_index=2',
                 shell=True)

```

Next, we go over the code in the preceding example and highlight where this is different from the examples we have seen thus far in the book.

The first block deals with imports and constants:

```

import tensorflow as tf
from tensorflow.contrib import slim
from tensorflow.examples.tutorials.mnist import input_data

BATCH_SIZE = 50
TRAINING_STEPS = 5000
PRINT_EVERY = 100
LOG_DIR = "/tmp/log"

```

Here we define:

**BATCH\_SIZE**

The number of examples to use during training in each mini-batch.

**TRAINING\_STEPS**

The total number of mini-batches we will use during training.

**PRINT\_EVERY**

How often to print diagnostic information. Since in the distributed training we use there is a single counter of the current step for all of the tasks, the print at a certain step will happen only from a single task.

**LOG\_DIR**

The training supervisor will save logs and temporary information to this location. Should be emptied between runs of the program, since old info could cause the next session to crash.

Next, we define the cluster, as discussed earlier in this chapter:

```

parameter_servers = ["localhost:2222"]
workers = ["localhost:2223",
           "localhost:2224",
           "localhost:2225"]

cluster = tf.train.ClusterSpec({"ps": parameter_servers, "worker": workers})

```



We run all tasks locally. In order to use multiple computers, replace localhost with the correct IP address. The ports 2222–2225 are also arbitrary, of course (but naturally have to be distinct when using a single machine): you might as well use the same port on all machines in a distributed setting.

In the following, we use the `tf.app.flags` mechanism to define two parameters that we will provide through the command line when we call the program on each task:

```
tf.app.flags.DEFINE_string("job_name", "", "'ps' / 'worker'")
tf.app.flags.DEFINE_integer("task_index", 0, "Index of task")
FLAGS = tf.app.flags.FLAGS
```

The parameters are as follows:

#### `job_name`

This will be either 'ps' for the single-parameter server, or 'worker' for each of the worker tasks.

#### `task_index`

The index of the task in each of the types of jobs. The parameter server will therefore use `task_index = 0`, and for the workers we will have 0, 1, and 2.

Now we are ready to use the identity of the current task in the cluster we defined in order to define the server for this current task. Note that this happens on each of the four tasks that we run. Each one of the four tasks knows its identity (`job_name`, `task_index`), as well as that of everybody else in the cluster (which is provided by the first argument):

```
server = tf.train.Server(cluster,
                        job_name=FLAGS.job_name,
                        task_index=FLAGS.task_index)
```

Before we start the actual training, we define our network and load the data to be used. This is similar to what we have done in previous examples, so we will not go into the details again here. We use TF-Slim for the sake of brevity:

```
mnist = input_data.read_data_sets('MNIST_data', one_hot=True)

def net(x):
    x_image = tf.reshape(x, [-1, 28, 28, 1])
    net = slim.layers.conv2d(x_image, 32, [5, 5], scope='conv1')
    net = slim.layers.max_pool2d(net, [2, 2], scope='pool1')
    net = slim.layers.conv2d(net, 64, [5, 5], scope='conv2')
    net = slim.layers.max_pool2d(net, [2, 2], scope='pool2')
    net = slim.layers.flatten(net, scope='flatten')
    net = slim.layers.fully_connected(net, 500, scope='fully_connected')
    net = slim.layers.fully_connected(net, 10, activation_fn=None, scope='pred')
    return net
```

The actual processing to do during training depends of the type of task. For the parameter server, we want the mechanism to, well, serve parameters, for the most part. This entails waiting for requests and processing them. This is all it takes to achieve this:

```
if FLAGS.job_name == "ps":
    server.join()
```

The `.join()` method of the server will not terminate even when all other tasks do, so this process will have to be killed externally once it is no longer needed.

In each of the worker tasks, we define the same computation graph:

```
with tf.device(tf.train.replica_device_setter(
    worker_device="/job:worker/task:%d" % FLAGS.task_index,
    cluster=cluster)):

    global_step = tf.get_variable('global_step', [],
                                  initializer=tf.constant_initializer(0),
                                  trainable=False)

    x = tf.placeholder(tf.float32, shape=[None, 784], name="x-input")
    y_ = tf.placeholder(tf.float32, shape=[None, 10], name="y-input")
    y = net(x)

    cross_entropy = tf.reduce_mean(
        tf.nn.softmax_cross_entropy_with_logits(y, y_))
    train_step = tf.train.AdamOptimizer(1e-4)\
        .minimize(cross_entropy, global_step=global_step)

    correct_prediction = tf.equal(tf.argmax(y, 1), tf.argmax(y_, 1))
    accuracy = tf.reduce_mean(tf.cast(correct_prediction, tf.float32))

    init_op = tf.global_variables_initializer()
```

We use `tf.train.replica_device_setter()` in order to specify this, meaning that the TensorFlow Variables will be synchronized through the parameter server (which is the mechanism that allows us to do the distributed computations).

The `global_step` Variable will hold the total number of steps during training across the tasks (each step index will occur only on a single task). This creates a timeline so that we can always know where we are in the grand scheme, from each of the tasks separately.

The rest of the code is the standard setup we have seen before in numerous examples throughout the book.

Next, we set up a Supervisor and a managed\_session:

```
sv = tf.train.Supervisor(is_chief=(FLAGS.task_index == 0),
                        logdir=LOG_DIR,
                        global_step=global_step,
```

```
init_op=init_op)
```

```
with sv.managed_session(server.target) as sess:
```

This is similar to the regular session we use throughout, except it is able to handle some aspects of the distribution. The initialization of the Variables will be done only in a single task (the chief designated via the `is_chief` argument; in our case, this will be the first worker task). All other tasks will wait for this to happen, then continue.

With the session live, we run training:

```
while not sv.should_stop() and step <= TRAINING_STEPS:

    batch_x, batch_y = mnist.train.next_batch(BATCH_SIZE)

    _, acc, step = sess.run([train_step, accuracy, global_step],
                            feed_dict={x: batch_x, y: batch_y})

    if step % PRINT_EVERY == 0:
        print "Worker : {}, Step: {}, Accuracy (batch): {}".format(
            FLAGS.task_index, step, acc)
```

Every `PRINT_EVERY` steps, we print the current accuracy on the current mini-batch. This will go to 100% pretty fast. For instance, the first two rows might be:

```
Worker : 1, Step: 0.0, Accuracy (batch): 0.140000000596
Worker : 0, Step: 100.0, Accuracy (batch): 0.860000014305
```

Finally, we run the test accuracy:

```
test_acc = sess.run(accuracy,
                    feed_dict={x: mnist.test.images, y: mnist.test.labels})
print "Test-Accuracy: {}".format(test_acc)
```

Note that this will execute on each of the worker tasks, and thus the same exact output will appear three times. In order to save on computation, we could have run this in only a single task (for instance, in the first worker only).

## Summary

In this chapter we covered the main concepts pertaining to parallelization in deep learning and machine learning in general, and concluded with an end-to-end example of distributed training on a cluster with data parallelization.

Distributed training is a very important tool that is utilized both in order to speed up training, and to train models that would otherwise be infeasible. In the next chapter we introduce the serving capabilities of TensorFlow, allowing trained models to be utilized in production environments.



---

# Exporting and Serving Models with TensorFlow

In this chapter we will learn how to save and export models by using both simple and advanced production-ready methods. For the latter we introduce TensorFlow Serving, one of TensorFlow's most practical tools for creating production environments. We start this chapter with a quick overview of two simple ways to save models and variables: first by manually saving the weights and reassigning them, and then by using the `Saver` class that creates training checkpoints for our variables and also exports our model. Finally, we shift to more advanced applications where we can deploy our model on a server by using TensorFlow Serving.

## Saving and Exporting Our Model

So far we've dealt with how to create, train, and track models with TensorFlow. Now we will see how to save a trained model. Saving the current state of our weights is crucial for obvious practical reasons—we don't want to have to retrain our model from scratch every time, and we also want a convenient way to share the state of our model with others (as in the pretrained models we saw in [Chapter 7](#)).

In this section we go over the basics of saving and exporting. We start with a simple way of saving and loading our weights to and from files. Then we will see how to use TensorFlow's `Saver` object to keep serialized model checkpoints that include information about both the state of our weights and our constructed graph.

## Assigning Loaded Weights

A naive but practical way to reuse our weights after training is saving them to a file, which we can later load to have them reassigned to the model.

Let's look at some examples. Say we wish to save the weights of the basic softmax model used for the MNIST data in [Chapter 2](#). After fetching them from the session, we have the weights represented as a NumPy array, and we save them in some format of our choice:

```
import numpy as np
weights = sess.run(W)
np.save(os.path.join(path, 'weight_storage'), weights)
```

Given that we have the exact same graph constructed, we can then load the file and assign the loaded weight values to the corresponding variables by using the `.assign()` method within a session:

```
loaded_w = np.load(path + 'weight_storage.npz')
loaded_w = loaded_w.items()[0][1]

x = tf.placeholder(tf.float32, [None, 784])
W = tf.Variable(tf.zeros([784, 10]))
y_true = tf.placeholder(tf.float32, [None, 10])
y_pred = tf.matmul(x, W)
cross_entropy = tf.reduce_mean(
    tf.nn.softmax_cross_entropy_with_logits(logits=y_pred,
                                             labels=y_true))

gd_step = tf.train.GradientDescentOptimizer(0.5)\
    .minimize(cross_entropy)

correct_mask = tf.equal(tf.argmax(y_pred, 1), tf.argmax(y_true, 1))
accuracy = tf.reduce_mean(tf.cast(correct_mask, tf.float32))

with tf.Session() as sess:
    # Assigning loaded weights
    sess.run(W.assign(loaded_w))
    acc = sess.run(accuracy, feed_dict={x: data.test.images,
                                        y_true: data.test.labels})

print("Accuracy: {}".format(acc))
```

```
Out:
Accuracy: 0.9199
```

Next, we will perform the same procedure, but this time for the CNN model used for the MNIST data in [Chapter 4](#). Here we have eight different sets of weights: two filter weights and their corresponding biases for the convolution layers 1 and 2, and two sets of weights and biases for the fully connected layer. We encapsulate the model inside a class so we can conveniently keep an updated list of these eight parameters.

We also add optional arguments for weights to load:

```
if weights is not None and sess is not None:
    self.load_weights(weights, sess)
```

and a function to assign their values when weights are passed:

```
def load_weights(self, weights, sess):
    for i,w in enumerate(weights):
        print("Weight index: {}".format(i),
              "Weight shape: {}".format(w.shape))
        sess.run(self.parameters[i].assign(w))
```

In its entirety:

```
class simple_cnn:
    def __init__(self, x_image,keep_prob, weights=None, sess=None):

        self.parameters = []
        self.x_image = x_image

        conv1 = self.conv_layer(x_image, shape=[5, 5, 1, 32])
        conv1_pool = self.max_pool_2x2(conv1)

        conv2 = self.conv_layer(conv1_pool, shape=[5, 5, 32, 64])
        conv2_pool = self.max_pool_2x2(conv2)

        conv2_flat = tf.reshape(conv2_pool, [-1, 7*7*64])
        full_1 = tf.nn.relu(self.full_layer(conv2_flat, 1024))

        full1_drop = tf.nn.dropout(full_1, keep_prob=keep_prob)

        self.y_conv = self.full_layer(full1_drop, 10)

        if weights is not None and sess is not None:
            self.load_weights(weights, sess)

    def weight_variable(self,shape):
        initial = tf.truncated_normal(shape, stddev=0.1)
        return tf.Variable(initial,name='weights')

    def bias_variable(self,shape):
        initial = tf.constant(0.1, shape=shape)
        return tf.Variable(initial,name='biases')

    def conv2d(self,x, W):
        return tf.nn.conv2d(x, W, strides=[1, 1, 1, 1],
                             padding='SAME')

    def max_pool_2x2(self,x):
        return tf.nn.max_pool(x, ksize=[1, 2, 2, 1],
```

```
strides=[1, 2, 2, 1], padding='SAME')
```

```
def conv_layer(self, input, shape):  
    W = self.weight_variable(shape)  
    b = self.bias_variable([shape[3]])  
    self.parameters += [W, b]  
  
    return tf.nn.relu(self.conv2d(input, W) + b)
```

```
def full_layer(self, input, size):  
    in_size = int(input.get_shape()[1])  
    W = self.weight_variable([in_size, size])  
    b = self.bias_variable([size])  
    self.parameters += [W, b]  
    return tf.matmul(input, W) + b
```

```
def load_weights(self, weights, sess):  
    for i,w in enumerate(weights):  
        print("Weight index: {}".format(i),  
              "Weight shape: {}".format(w.shape))  
        sess.run(self.parameters[i].assign(w))
```

In this example the model was already trained and the weights were saved as `cnn_weights`. We load the weights and pass them to our CNN object. When we run the model on the test data, it will be using the pretrained weights:

```
x = tf.placeholder(tf.float32, shape=[None, 784])  
x_image = tf.reshape(x, [-1, 28, 28, 1])  
y_ = tf.placeholder(tf.float32, shape=[None, 10])  
keep_prob = tf.placeholder(tf.float32)  
  
sess = tf.Session()  
  
weights = np.load(path + 'cnn_weight_storage.npz')  
weights = weights.items()[0][1]  
cnn = simple_cnn(x_image, keep_prob, weights, sess)  
  
cross_entropy = tf.reduce_mean(  
    tf.nn.softmax_cross_entropy_with_logits(  
        logits=cnn.y_conv,  
        labels=y_))  
train_step = tf.train.AdamOptimizer(1e-4).minimize(cross_entropy)  
  
correct_prediction = tf.equal(tf.argmax(cnn.y_conv, 1),  
                              tf.argmax(y_, 1))  
accuracy = tf.reduce_mean(tf.cast(correct_prediction, tf.float32))  
  
X = data.test.images.reshape(10, 1000, 784)  
Y = data.test.labels.reshape(10, 1000, 10)
```



```

test_accuracy = np.mean([sess.run(accuracy,
                                feed_dict={x:X[i], y_:Y[i],keep_prob:1.0})
                        for i in range(10)])

sess.close()

print("test accuracy: {}".format(test_accuracy))

Out:
Weight index: 0 Weight shape: (5, 5, 1, 32)
Weight index: 1 Weight shape: (32,)
Weight index: 2 Weight shape: (5, 5, 32, 64)
Weight index: 3 Weight shape: (64,)
Weight index: 4 Weight shape: (3136, 1024)
Weight index: 5 Weight shape: (1024,)
Weight index: 6 Weight shape: (1024, 10)
Weight index: 7 Weight shape: (10,)

test accuracy: 0.990100026131

```

And we obtain high accuracy without the need to retrain.

## The Saver Class

TensorFlow also has a built-in class we can use for the same purpose as in the previous examples, offering additional useful features as we will see shortly. This class is referred to as the Saver class (already briefly presented in [Chapter 5](#)).

Saver adds operations that allow us to save and restore the model's parameters by using binary files called *checkpoint files*, mapping the tensor values to the names of the variables. Unlike the method used in the previous section, here we don't have to keep track of our parameters—Saver does it automatically for us.

Using Saver is straightforward. We first create a saver instance by using `tf.train.Saver()`, indicating how many recent variable checkpoints we would like to keep and optionally the time interval at which to keep them.

For example, in the following code we ask that only the seven most recent checkpoints will be kept, and in addition we specify that one checkpoint be kept each half hour (this can be useful for performance and progression evaluation analysis):

```

saver = tf.train.Saver(max_to_keep=7,
                      keep_checkpoint_every_n_hours=0.5)

```

If no inputs are given, the default is to keep the last five checkpoints, and the `every_n_hours` feature is effectively disabled (it's set to 10000 by default).

Next we save the checkpoint files by using the `.save()` method of the saver instance, passing the session argument, the path where the files are to be saved, and also the step number (`global_step`), which is automatically concatenated to the

name of each checkpoint file as an indication of its iteration count. This creates multiple checkpoints at different steps while training a model.

In this code example, every 50 training iterations a file will be saved in the designated directory:

```
DIR = "path/to/model"

with tf.Session() as sess:
    for step in range(1, NUM_STEPS+1):
        batch_xs, batch_ys = data.train.next_batch(MINIBATCH_SIZE)
        sess.run(gd_step, feed_dict={x: batch_xs, y_true: batch_ys})

        if step % 50 == 0:
            saver.save(sess, os.path.join(DIR, "model"),
                       global_step=step)
```

An additional saved file carrying the name *checkpoint* contains the list of saved checkpoints, and also the path to the most recent checkpoint:

```
model_checkpoint_path: "model_ckpt-1000"
all_model_checkpoint_paths: "model_ckpt-700"
all_model_checkpoint_paths: "model_ckpt-750"
all_model_checkpoint_paths: "model_ckpt-800"
all_model_checkpoint_paths: "model_ckpt-850"
all_model_checkpoint_paths: "model_ckpt-900"
all_model_checkpoint_paths: "model_ckpt-950"
all_model_checkpoint_paths: "model_ckpt-1000"
```

In the following code we use Saver to save the state of the weights:

```
from tensorflow.examples.tutorials.mnist import input_data
DATA_DIR = '/tmp/data'
data = input_data.read_data_sets(DATA_DIR, one_hot=True)

NUM_STEPS = 1000
MINIBATCH_SIZE = 100

DIR = "path/to/model"

x = tf.placeholder(tf.float32, [None, 784], name='x')
W = tf.Variable(tf.zeros([784, 10]), name='W')
y_true = tf.placeholder(tf.float32, [None, 10])
y_pred = tf.matmul(x, W)
cross_entropy = tf.reduce_mean(
    tf.nn.softmax_cross_entropy_with_logits(logits=y_pred,
```

```

                                labels=y_true))
gd_step = tf.train.GradientDescentOptimizer(0.5)\
                                .minimize(cross_entropy)
correct_mask = tf.equal(tf.argmax(y_pred, 1), tf.argmax(y_true, 1))
accuracy = tf.reduce_mean(tf.cast(correct_mask, tf.float32))

saver = tf.train.Saver(max_to_keep=7,
                       keep_checkpoint_every_n_hours=1)

with tf.Session() as sess:
    sess.run(tf.global_variables_initializer())
    for step in range(1, NUM_STEPS+1):
        batch_xs, batch_ys = data.train.next_batch(MINIBATCH_SIZE)
        sess.run(gd_step, feed_dict={x: batch_xs, y_true: batch_ys})

        if step % 50 == 0:
            saver.save(sess, os.path.join(DIR, "model_ckpt"),
                       global_step=step)

    ans = sess.run(accuracy, feed_dict={x: data.test.images,
                                       y_true: data.test.labels})

print("Accuracy: {:.4}%".format(ans*100))

```

Out:  
Accuracy: 90.87%

And now we simply restore the checkpoint we want for the same graph model by using `saver.restore()`, and the weights are automatically assigned to the model:

```

tf.reset_default_graph()
x = tf.placeholder(tf.float32, [None, 784], name='x')
W = tf.Variable(tf.zeros([784, 10]), name='W')
y_true = tf.placeholder(tf.float32, [None, 10])
y_pred = tf.matmul(x, W)
cross_entropy = tf.reduce_mean(
    tf.nn.softmax_cross_entropy_with_logits(logits=y_pred,
                                           labels=y_true))
gd_step = tf.train.GradientDescentOptimizer(0.5)\
                                .minimize(cross_entropy)
correct_mask = tf.equal(tf.argmax(y_pred, 1), tf.argmax(y_true, 1))
accuracy = tf.reduce_mean(tf.cast(correct_mask, tf.float32))

saver = tf.train.Saver()

with tf.Session() as sess:
    saver.restore(sess, os.path.join(DIR, "model_ckpt-1000"))
    ans = sess.run(accuracy, feed_dict={x: data.test.images,
                                       y_true: data.test.labels})

print("Accuracy: {:.4}%".format(ans*100))

```

Out:  
Accuracy: 90.87%



### Resetting the graph before restoring

The loaded variables need to be paired with the ones in the current graph, and thus should have matching names. If for some reason the names don't match, then an error similar to this might follow:

```
NotFoundError: Key W_1 not found in checkpoint
[[Node: save/RestoreV2_2 = RestoreV2[
  dtypes=[DT_FLOAT], _device="/job:localhost/replica:0
/task:0/cpu:0"](_recv_save/Const_1_0, save/RestoreV2_2
/tensor_names, save/RestoreV2_2/shape_and_slices)]]
```

This can happen if the names were used by some old, irrelevant graph. By using the `tf.reset_default_graph()` command to reset the graph, you can solve this issue.

So far, in both methods we needed to re-create the graph for the restored parameters to be reassigned. Saver, however, also allows us to restore the graph without having to reconstruct it by generating *.meta* checkpoint files containing all the required information about it.

The information about the graph and how to incorporate the saved weights in it (metainformation) is referred to as the `MetaGraphDef`. This information is serialized—transformed to a string—using protocol buffers (see “[Serialization and Protocol Buffers](#)” on page 191), and it includes several parts. The information about the architecture of the network is kept in `graph_def`.

Here is a little sample of textual serialization of the graph information (more about serialization follows):

```
meta_info_def {
  stripped_op_list {
    op {
      name: "ApplyGradientDescent"
      input_arg {
        name: "var"
        type_attr: "T"
        is_ref: true
      }
      input_arg {
        name: "alpha"
        type_attr: "T"
      }
      ...
    }
  }
}

graph_def {
  node {
    name: "Placeholder"
```

```

op: "Placeholder"
attr {
  key: "_output_shapes"
  value {
    list {
      shape {
        dim {
          size: -1
        }
        dim {
          size: 784
        }
      }
    }
  }
}...

```

In order to load the saved graph, we use `tf.train.import_meta_graph()`, passing the name of the checkpoint file we want (with the *.meta* extension). TensorFlow already knows what to do with the restored weights, since this information is also kept:

```

tf.reset_default_graph()
DIR = "path/to/model"

with tf.Session() as sess:
    saver = tf.train.import_meta_graph(os.path.join(
        DIR, "model_ckpt-1000.meta"))
    saver.restore(sess, os.path.join(DIR, "model_ckpt-1000"))

    ans = sess.run(accuracy, feed_dict={x: data.test.images,
        y_true: data.test.labels})

    print("Accuracy: {:.4}%".format(ans*100))

```

Simply importing the graph and restoring the weights, however, is not enough and will result in an error. The reason is that importing the model and restoring the weights doesn't give us additional access to the variables used as arguments when running the session (fetches and keys of `feed_dict`)—the model doesn't know what the inputs and outputs are, what measures we wish to calculate, etc.

One way to solve this problem is by saving them in a collection. A collection is a TensorFlow object similar to a dictionary, in which we can keep our graph components in an orderly, accessible fashion.

In this example we want to have access to the measure accuracy (which we wish to fetch) and the feed keys `x` and `y_true`. We add them to a collection before saving the model under the name of `train_var`:

```

train_var = [x,y_true,accuracy]
tf.add_to_collection('train_var', train_var[0])
tf.add_to_collection('train_var', train_var[1])
tf.add_to_collection('train_var', train_var[2])

```

As shown, the `saver.save()` method automatically saves the graph architecture together with the weights' checkpoints. We can also save the graph explicitly using `saver.export_meta_graph()`, and then add a collection (passed as the second argument):

```

train_var = [x,y_true,accuracy]
tf.add_to_collection('train_var', train_var[0])
tf.add_to_collection('train_var', train_var[1])
tf.add_to_collection('train_var', train_var[2])

saver = tf.train.Saver(max_to_keep=7,
                       keep_checkpoint_every_n_hours=1)
saver.export_meta_graph(os.path.join(DIR, "model_ckpt.meta")
                       ,collection_list=['train_var'])

```

Now we retrieve the graph together with the collection, from which we can extract the required variables:

```

tf.reset_default_graph()
DIR = "path/to/model"

with tf.Session() as sess:
    sess.run(tf.global_variables_initializer())

    saver = tf.train.import_meta_graph(os.path.join(
        DIR, "model_ckpt.meta")
    saver.restore(sess, os.path.join(DIR, "model_ckpt-1000"))
    x = tf.get_collection('train_var')[0]
    y_true = tf.get_collection('train_var')[1]
    accuracy = tf.get_collection('train_var')[2]

    ans = sess.run(accuracy, feed_dict={x: data.test.images,
        y_true: data.test.labels})
print("Accuracy: {:.4}%".format(ans*100))

```

```

Out:
Accuracy: 91.4%

```

When defining the graph, think about which variables/operations you would like to retrieve once the graph has been saved and restored, such as the accuracy operation in the preceding example. In the next section, when we talk about Serving, we'll see

that it has built-in functionality for guiding the exported model without the need to save the variables as we do here.

## Serialization and Protocol Buffers

When we run a program, the state of our code-produced data structure is stored in memory. Whenever we want to either make a copy of this data structure, save it to a file, or transfer it somewhere, we need to translate it to some representation that can be efficiently saved or sent through a connection in a sequential manner. We do that by what is referred to as the process of *serialization*, where we use some function that flattens our data as a string. This string can then later be deserialized to a code format by applying the same serializing function in a reversed order.

While in simple data structure instances this may be trivial to do (e.g., representing an array as a simple concatenation of its values), in complex data structures that have nested arrays, dictionaries, and objects, the approach to take is not as straightforward.

There are several popular representations for serialization—perhaps the most famous ones you may have heard of or even worked with are JSON and XML. Both have nested elements that belong within a set of delimiters. In JSON all elements are comma-separated; arrays are denoted with square brackets and objects by curly braces. XML, which at its core is a markup language, uses tags for the same purpose.

The serialized string can be encoded either in a readable, human-friendly text format, making it easier to check and debug it with any text editor, or in a machine-friendly binary format, which can sometimes be more compact.

Protocol buffers, or *protobufs* for short, is the format TensorFlow uses to transfer data, developed internally by Google. Protobufs (mentioned in [Chapter 8](#), when reading data was discussed) can be used either as an uncompressed text format for debugging and editing or a more compact binary format.

## Introduction to TensorFlow Serving

TensorFlow Serving, written in C++, is a high-performance serving framework with which we can deploy our model in a production setting. It makes our model usable for production by enabling client software to access it and pass inputs through Serving's API ([Figure 10-1](#)). Of course, TensorFlow Serving is designed to have seamless integration with TensorFlow models. Serving features many optimizations to reduce latency and increase throughput of predictions, useful for real-time, large-scale applications. It's not only about accessibility and efficient serving of predictions, but also about flexibility—it's quite common to want to keep a model updated for various reasons, like having additional training data for improving the model, making changes to the network architecture, and more.

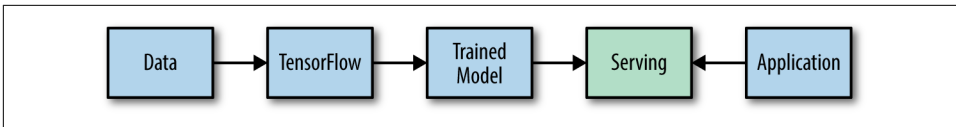

Figure 10-1. Serving links our trained model to external applications, allowing client software easy access.

## Overview

Say that we run a speech-recognition service and we want to deploy our models with TensorFlow Serving. In addition to optimized serving, it is important for us to update our models periodically as we obtain more data or experiment with new network architectures. In slightly more technical terms, we'd like to have the ability to load new models and serve their outputs, and unload old ones, all while streamlining model life-cycle management and version policies.

In general terms, we can accomplish this with Serving as follows. In Python, we define the model and prepare it to be serialized in a way that can be parsed by the different modules responsible for loading, serving, and managing versions, for example. The core Serving “engine” resides in a C++ module that we will need to access only if we wish to control specific tuning and customization of Serving behaviors.

In a nutshell, this is how Serving’s architecture works (Figure 10-2):

- A module called `Source` identifies new models to be loaded by monitoring plugged-in filesystems, which contain our models and their associated information that we exported upon creation. `Source` includes submodules that periodically inspect the filesystem and determine the latest relevant model versions.
- When it identifies a new model version, `source` creates a `loader`. The loader passes its `servables` (objects that clients use to perform computations such as predictions) to a `manager`. The manager handles the full life cycle of servables (loading, unloading, and serving) according to a version policy (gradual rollout, reverting versions, etc.).
- Finally, the manager provides an interface for client access to servables.

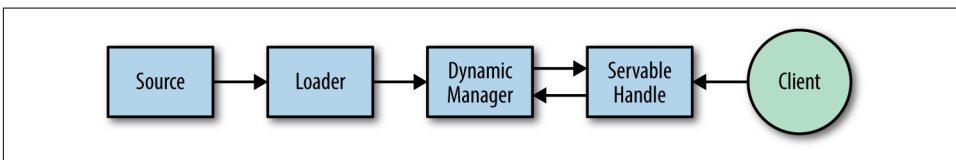

Figure 10-2. An outline of the Serving architecture.



What's especially nice about how Serving is built is that it's designed to be flexible and extendable. It supports building various plug-ins to customize system behavior, while using the generic builds of other core components.

In the next section we will build and deploy a TensorFlow model with Serving, demonstrating some of its key functionalities and inner workings. In advanced applications it is likely that we may have to control for different types of optimizations and customization; for example, controlling version policies and more. In this chapter we show you how to get up and running with Serving and understand its fundamentals, laying the foundations for production-ready deployment.

## Installation

Serving requires several installations, including some third-party components. The installation can be done from source or using Docker, which we use here to get you started quickly. A Docker container bundles together a software application with everything needed to run it (for example, code, files, etc.). We also use Bazel, Google's own build tool for building client and server software. In this chapter we only briefly touch on the technicalities behind tools such as Bazel and Docker. More comprehensive descriptions appear in [the appendix](#), at the end of the book.

### Installing Serving

Docker installation instructions can be found in on [the Docker website](#).

Here, we demonstrate the Docker setup using [Ubuntu](#).

Docker containers are created from a local Docker image, which is built from a `dockerfile`, and encapsulates everything we need (dependency installations, project code, etc.). Once we have Docker installed, we need to [download the TensorFlow Serving dockerfile](#).

This `dockerfile` contains all of the dependencies needed to build TensorFlow Serving.

First, we produce the image from which we can run containers (this may take some time):

```
docker build --pull -t $USER/tensorflow-serving-devel -f
                                Dockerfile.devel .
```

Now that we've got the image created locally on our machine, we can create and run a container by using:

```
docker run -v $HOME/docker_files:/host_files
            -p 80:80 -it $USER/tensorflow-serving-devel
```

The `docker run -it $USER/tensorflow-serving-devel` command would suffice to create and run a container, but we make two additions to this command.

First, we add `-v $HOME/home_dir:/docker_dir`, where `-v` (volume) indicates a request for a shared filesystem so we have a convenient way to transfer files between the Docker container and the host. Here we created the shared folders `docker_files` on our host and `host_files` on our Docker container. Another way to transfer files is simply by using the command `docker cp foo.txt mycontainer:/foo.txt`. The second addition is `-p <host port>:<container port>`, which makes the service in the container accessible from anywhere by having the indicated port exposed.

Once we enter our `run` command, a container will be created and started, and a terminal will be opened. We can have a look at our container's status by using the command `docker ps -a` (outside the Docker terminal). Note that each time we use the `docker run` command, we create another container; to enter the terminal of an existing container, we need to use `docker exec -it <container id> bash`.

Finally, within the opened terminal we clone and configure TensorFlow Serving:

```
git clone --recurse-submodules https://github.com/tensorflow/serving
cd serving/tensorflow
./configure
```

And that's it; we're ready to go!

## Building and Exporting

Now that Serving is cloned and operational, we can start exploring its features and how to use it. The cloned TensorFlow Serving libraries are organized in a Bazel architecture. The source code Bazel builds upon is organized in a workspace directory, inside nested hierarchies of packages that group related source files together. Each package has a `BUILD` file, specifying the output to be built from the files inside that package.

The workspace in our cloned library is located in the `/serving` folder, containing the `WORKSPACE` text file and the `/tensorflow_serving` package, which we will return to later.

We now turn to look at the Python script that handles the training and exportation of the model, and see how to export our model in a manner ready for serving.

### Exporting our model

As when we used the Saver class, our trained model will be serialized and exported to two files: one that contains information about our variables, and another that holds information about our graph and other metadata. As we shall see shortly, Serving requires a specific serialization format and metadata, so we cannot simply use the Saver class, as we saw at the beginning of this chapter.

The steps we are going to take are as follows:

1. Define our model as in previous chapters.
2. Create a model builder instance.
3. Have our metadata (model, method, inputs and outputs, etc.) defined in the builder in a serialized format (this is referred to as `SignatureDef`).
4. Save our model by using the builder.

We start by creating a builder instance using Serving's `SavedModelBuilder` module, passing the location to which we want our files to be exported (the directory will be created if it does not exist). `SavedModelBuilder` exports serialized files representing our model in the required format:

```
builder = saved_model_builder.SavedModelBuilder(export_path)
```

The serialized model files we need will be contained in a directory whose name will specify the model and its version:

```
export_path_base = sys.argv[-1]
export_path = os.path.join(
    compat.as_bytes(export_path_base),
    compat.as_bytes(str(FLAGS.model_version)))
```

This way, each version will be exported to a distinct subdirectory with its corresponding path.

Note that the `export_path_base` is obtained as input from the command line with `sys.argv`, and the version is kept as a flag (presented in the previous chapter). Flag parsing is handled by `tf.app.run()`, as we will see shortly.

Next, we want to define the input (shape of the input tensor of the graph) and output (tensor of the prediction) signatures. In the first part of this chapter we used TensorFlow collection objects to specify the relation between input and output data and their corresponding placeholders, and also operations for computing predictions and accuracy. Here, signatures serve a somewhat analogous purpose.

We use the builder instance we created to add both the variables and meta graph information, using the `SavedModelBuilder.add_meta_graph_and_variables()` method:

```

builder.add_meta_graph_and_variables(
    sess, [tag_constants.SERVING],
    signature_def_map={
        'predict_images':
            prediction_signature,
        signature_constants.DEFAULT_SERVING_SIGNATURE_DEF_KEY:
            classification_signature,
    },
    legacy_init_op=legacy_init_op)

```

We need to pass four arguments: the session, tags (to “serve” or “train”), the signature map, and some initializations.

We pass a dictionary with the prediction and classification signatures. We start with the prediction signature, which again can be thought of as analogical to specifying and saving a prediction op in a TensorFlow collection as we saw earlier:

```

prediction_signature = signature_def_utils.build_signature_def(
    inputs={'images': tensor_info_x},
    outputs={'scores': tensor_info_y},
    method_name=signature_constants.PREDICT_METHOD_NAME)

```

images and scores here are arbitrary names that we will use to refer to our x and y Tensors later. The images and scores are encoded into the required format by using the following commands:

```

tensor_info_x = utils.build_tensor_info(x)
tensor_info_y = utils.build_tensor_info(y_conv)

```

Similar to the prediction signature, we have the classification signature, where we input the information about the scores (the probability values of the top k classes) and the corresponding classes:

```

# Build the signature_def_map
classification_inputs = utils.build_tensor_info(
    serialized_tf_example)
classification_outputs_classes = utils.build_tensor_info(
    prediction_classes)
classification_outputs_scores = utils.build_tensor_info(values)
classification_signature = signature_def_utils.build_signature_def(
    inputs={signature_constants.CLASSIFY_INPUTS:
            classification_inputs},
    outputs={
        signature_constants.CLASSIFY_OUTPUT_CLASSES:
            classification_outputs_classes,
        signature_constants.CLASSIFY_OUTPUT_SCORES:
            classification_outputs_scores
    },
    method_name=signature_constants.CLASSIFY_METHOD_NAME)

```

Finally, we save our model by using the save() command:

```
builder.save()
```

This, in a nutshell, wraps all the parts together in a format ready to be serialized and exported upon execution of the script, as we shall see immediately.

Here is the final code for our main Python model script, including our model (the CNN model from [Chapter 4](#)):

```
import os
import sys
import tensorflow as tf
from tensorflow.python.saved_model import builder
                                as saved_model_builder
from tensorflow.python.saved_model import signature_constants
from tensorflow.python.saved_model import signature_def_utils
from tensorflow.python.saved_model import tag_constants
from tensorflow.python.saved_model import utils
from tensorflow.python.util import compat
from tensorflow_serving.example import mnist_input_data

tf.app.flags.DEFINE_integer('training_iteration', 10,
                            'number of training iterations.')
tf.app.flags.DEFINE_integer(
    'model_version', 1, 'version number of the model.')
tf.app.flags.DEFINE_string('work_dir', '/tmp', 'Working directory.')
FLAGS = tf.app.flags.FLAGS

def weight_variable(shape):
    initial = tf.truncated_normal(shape, stddev=0.1)
    return tf.Variable(initial, dtype='float')

def bias_variable(shape):
    initial = tf.constant(0.1, shape=shape)
    return tf.Variable(initial, dtype='float')

def conv2d(x, W):
    return tf.nn.conv2d(x, W, strides=[1, 1, 1, 1], padding='SAME')

def max_pool_2x2(x):
    return tf.nn.max_pool(x, ksize=[1, 2, 2, 1],
                          strides=[1, 2, 2, 1], padding='SAME')

def main(_):
    if len(sys.argv) < 2 or sys.argv[-1].startswith('-'):
        print('Usage: mnist_export.py [--training_iteration=x] '
              '[--model_version=y] export_dir')
        sys.exit(-1)
    if FLAGS.training_iteration <= 0:
        print('Please specify a positive
              value for training iteration.')
        sys.exit(-1)
    if FLAGS.model_version <= 0:
```

```

print ('Please specify a positive
      value for version number.')
sys.exit(-1)

print('Training...')
mnist = mnist_input_data.read_data_sets(
    FLAGS.work_dir, one_hot=True)
sess = tf.InteractiveSession()
serialized_tf_example = tf.placeholder(
    tf.string, name='tf_example')
feature_configs = {'x': tf.FixedLenFeature(shape=[784],
    dtype=tf.float32),}
tf_example = tf.parse_example(serialized_tf_example,
    feature_configs)

x = tf.identity(tf_example['x'], name='x')
y_ = tf.placeholder('float', shape=[None, 10])

W_conv1 = weight_variable([5, 5, 1, 32])
b_conv1 = bias_variable([32])
x_image = tf.reshape(x, [-1,28,28,1])

h_conv1 = tf.nn.relu(conv2d(x_image, W_conv1) + b_conv1)
h_pool1 = max_pool_2x2(h_conv1)

W_conv2 = weight_variable([5, 5, 32, 64])
b_conv2 = bias_variable([64])

h_conv2 = tf.nn.relu(conv2d(h_pool1, W_conv2) + b_conv2)
h_pool2 = max_pool_2x2(h_conv2)

W_fc1 = weight_variable([7 * 7 * 64, 1024])
b_fc1 = bias_variable([1024])

h_pool2_flat = tf.reshape(h_pool2, [-1, 7*7*64])
h_fc1 = tf.nn.relu(tf.matmul(h_pool2_flat, W_fc1) + b_fc1)

keep_prob = tf.placeholder(tf.float32)
h_fc1_drop = tf.nn.dropout(h_fc1, keep_prob)

W_fc2 = weight_variable([1024, 10])
b_fc2 = bias_variable([10])

y_conv = tf.matmul(h_fc1_drop, W_fc2) + b_fc2

y = tf.nn.softmax(y_conv, name='y')
cross_entropy = -tf.reduce_sum(y_ * tf.log(y_conv))

```

```

train_step = tf.train.AdamOptimizer(1e-4)\
    .minimize(cross_entropy)

values, indices = tf.nn.top_k(y_conv, 10)
prediction_classes = tf.contrib.lookup.index_to_string(
    tf.to_int64(indices),
    mapping=tf.constant([str(i) for i in xrange(10)]))

sess.run(tf.global_variables_initializer())

for _ in range(FLAGS.training_iteration):
    batch = mnist.train.next_batch(50)

    train_step.run(feed_dict={x: batch[0],
                              y_: batch[1], keep_prob: 0.5})
    print(_)
    correct_prediction = tf.equal(tf.argmax(y_conv,1),
                                  tf.argmax(y_,1))

accuracy = tf.reduce_mean(tf.cast(correct_prediction, 'float'))
    y_: mnist.test.labels})

print('training accuracy %g' % accuracy.eval(feed_dict={
    x: mnist.test.images,
    y_: mnist.test.labels, keep_prob: 1.0}))

print('training is finished!')

export_path_base = sys.argv[-1]
export_path = os.path.join(
    compat.as_bytes(export_path_base),
    compat.as_bytes(str(FLAGS.model_version)))
print 'Exporting trained model to', export_path
builder = saved_model_builder.SavedModelBuilder(export_path)

classification_inputs = utils.build_tensor_info(
    serialized_tf_example)
classification_outputs_classes = utils.build_tensor_info(
    prediction_classes)
classification_outputs_scores = utils.build_tensor_info(values)

classification_signature = signature_def_utils.build_signature_def(
    inputs={signature_constants.CLASSIFY_INPUTS:
            classification_inputs},
    outputs={
        signature_constants.CLASSIFY_OUTPUT_CLASSES:
            classification_outputs_classes,
        signature_constants.CLASSIFY_OUTPUT_SCORES:
            classification_outputs_scores
    },

```

```

        method_name=signature_constants.CLASSIFY_METHOD_NAME)

    tensor_info_x = utils.build_tensor_info(x)
    tensor_info_y = utils.build_tensor_info(y_conv)

    prediction_signature = signature_def_utils.build_signature_def(
        inputs={'images': tensor_info_x},
        outputs={'scores': tensor_info_y},
        method_name=signature_constants.PREDICT_METHOD_NAME)

    legacy_init_op = tf.group(tf.initialize_all_tables(),
                              name='legacy_init_op')
    builder.add_meta_graph_and_variables(
        sess, [tag_constants.SERVING],
        signature_def_map={
            'predict_images':
                prediction_signature,
            signature_constants.DEFAULT_SERVING_SIGNATURE_DEF_KEY:
                classification_signature,
        },
        legacy_init_op=legacy_init_op)

    builder.save()

    print('new model exported!')

if __name__ == '__main__':
    tf.app.run()

```

The `tf.app.run()` command gives us a nice wrapper that handles parsing command-line arguments.

In the final part of our introduction to Serving, we use Bazel for the actual exporting and deployment of our model.

Most Bazel *BUILD* files consist only of declarations of build rules specifying the relationship between inputs and outputs, and the steps to build the outputs.

For instance, in this *BUILD* file we have a Python rule `py_binary` to build executable programs. Here we have three attributes, `name` for the name of the rule, `srcs` for the list of files that are processed to create the target (our Python script), and `deps` for the list of other libraries to be linked into the binary target:

```

py_binary(
    name = "serving_model_ch4",
    srcs = [
        "serving_model_ch4.py",
    ],
    deps = [
        ":mnist_input_data",
        "@org_tensorflow//tensorflow:tensorflow_py",
    ],
)

```



```

"@org_tensorflow//tensorflow/python/saved_model:builder",
"@org_tensorflow//tensorflow/python/saved_model:constants",
"@org_tensorflow//tensorflow/python/saved_model:loader",
"@org_tensorflow//tensorflow/python/saved_model:
    signature_constants",
"@org_tensorflow//tensorflow/python/saved_model:
    signature_def_utils",
"@org_tensorflow//tensorflow/python/saved_model:
    tag_constants",
"@org_tensorflow//tensorflow/python/saved_model:utils",
],
)

```

Next we run and export the model by using Bazel, training with 1,000 iterations and exporting the first version of the model:

```

bazel build //tensorflow_serving/example:serving_model_ch4
bazel-bin/tensorflow_serving/example/serving_model_ch4
  --training_iteration=1000 --model_version=1 /tmp/mnist_model

```

To train the second version of the model, we just use:

```
--model_version=2
```

In the designated subdirectory we will find two files, *saved\_model.pb* and *variables*, that contain the serialized information about our graph (including metadata) and its variables, respectively. In the next lines we load the exported model with the standard TensorFlow model server:

```

bazel build //tensorflow_serving/model_servers:
    tensorflow_model_server
bazel-bin/tensorflow_serving/model_servers/tensorflow_model_server
  --port=8000 --model_name=mnist
  --model_base_path=/tmp/mnist_model/ --logtostderr

```

Finally, our model is now served and ready for action at `localhost:8000`. We can test the server with a simple client utility, `mnist_client`:

```

bazel build //tensorflow_serving/example:mnist_client
bazel-bin/tensorflow_serving/example/mnist_client
  --num_tests=1000 --server=localhost:8000

```

## Summary

This chapter dealt with how to save, export, and serve models, from simply saving and reassigning of weights using the built-in Saver utility to an advanced model-deployment mechanism for production. The last part of this chapter touched on TensorFlow Serving, a great tool for making our models commercial-ready with dynamic version control. Serving is a rich utility with many functionalities, and we strongly recommend that readers who are interested in mastering it seek out more in-depth technical material online.



---

# Tips on Model Construction and Using TensorFlow Serving

## Model Structuring and Customization

In this short section we will focus on two topics that continue from and extend the previous chapters—how to construct a proper model, and how to customize the model’s entities. We start by describing how we can effectively reframe our code by using encapsulations and allow its variables to be shared and reused. In the second part of this section we will talk about how to customize our own loss functions and operations and use them for optimization.

### Model Structuring

Ultimately, we would like to design our TensorFlow code efficiently, so that it can be reused for multiple tasks and is easy to follow and pass around. One way to make things cleaner is to use one of the available TensorFlow extension libraries, which were discussed in [Chapter 7](#). However, while they are great to use for typical networks, models with new components that we wish to implement may sometimes require the full flexibility of lower-level TensorFlow.

Let's take another look at the optimization code from the previous chapter:

```
import tensorflow as tf

NUM_STEPS = 10

g = tf.Graph()
wb_ = []
with g.as_default():
    x = tf.placeholder(tf.float32, shape=[None, 3])
    y_true = tf.placeholder(tf.float32, shape=None)

    with tf.name_scope('inference') as scope:
        w = tf.Variable([[0, 0, 0]], dtype=tf.float32, name='weights')
        b = tf.Variable(0, dtype=tf.float32, name='bias')
        y_pred = tf.matmul(w, tf.transpose(x)) + b

    with tf.name_scope('loss') as scope:
        loss = tf.reduce_mean(tf.square(y_true - y_pred))

    with tf.name_scope('train') as scope:
        learning_rate = 0.5
        optimizer = tf.train.GradientDescentOptimizer(learning_rate)
        train = optimizer.minimize(loss)

init = tf.global_variables_initializer()
with tf.Session() as sess:
    sess.run(init)
    for step in range(NUM_STEPS):
        sess.run(train, {x: x_data, y_true: y_data})
        if (step % 5 == 0):
            print(step, sess.run([w, b]))
            wb_.append(sess.run([w, b]))

print(10, sess.run([w, b]))
```

We get:

```
(0, [array([[ 0.30149955,  0.49303722,  0.11409992]],
           dtype=float32), -0.18563795])
(5, [array([[ 0.30094019,  0.49846715,  0.09822173]],
           dtype=float32), -0.19780949])
(10, [array([[ 0.30094025,  0.49846718,  0.09822182]],
           dtype=float32), -0.19780946])
```

The entire code here is simply stacked line by line. This is OK for simple and focused examples. However, this way of coding has its limits—it's neither reusable nor very readable when the code gets more complex.

Let's zoom out and think about what characteristics our infrastructure should have. First, we would like to encapsulate the model so it can be used for various tasks like training, evaluation, and forming predictions. Furthermore, it can also be more effi-

cient to construct the model in a modular fashion, giving us specific control over its subcomponents and increasing readability. This will be the focus of the next few sections.

## Modular design

A good start is to split the code into functions that capture different elements in the learning model. We can do this as follows:

```
def predict(x,y_true,w,b):
    y_pred = tf.matmul(w,tf.transpose(x)) + b
    return y_pred

def get_loss(y_pred,y_true):
    loss = tf.reduce_mean(tf.square(y_true-y_pred))
    return loss

def get_optimizer(y_pred,y_true):
    loss = get_loss(y_pred,y_true)
    optimizer = tf.train.GradientDescentOptimizer(0.5)
    train = optimizer.minimize(loss)
    return train

def run_model(x_data,y_data):
    wb_ = []
    # Define placeholders and variables
    x = tf.placeholder(tf.float32,shape=[None,3])
    y_true = tf.placeholder(tf.float32,shape=None)
    w = tf.Variable([[0,0,0]],dtype=tf.float32)
    b = tf.Variable(0,dtype=tf.float32)
    print(b.name)

    # Form predictions
    y_pred = predict(x,y_true,w,b)

    # Create optimizer
    train = get_optimizer(y_pred,y_data)

    # Run session
    init = tf.global_variables_initializer()
    with tf.Session() as sess:
        sess.run(init)
        for step in range(10):
            sess.run(train,{x: x_data, y_true: y_data})
            if (step % 5 == 0):
                print(step, sess.run([w,b]))
                wb_.append(sess.run([w,b]))

run_model(x_data,y_data)
run_model(x_data,y_data)
```

And here is the result:

```
Variable_9:0 Variable_8:0
0 [array([[ 0.27383861,  0.48421991,  0.09082422]],
          dtype=float32), -0.20805186]
4 [array([[ 0.29868397,  0.49840903,  0.10026278]],
          dtype=float32), -0.20003076]
9 [array([[ 0.29868546,  0.49840906,  0.10026464]],
          dtype=float32), -0.20003042]

Variable_11:0 Variable_10:0
0 [array([[ 0.27383861,  0.48421991,  0.09082422]],
          dtype=float32), -0.20805186]
4 [array([[ 0.29868397,  0.49840903,  0.10026278]],
          dtype=float32), -0.20003076]
9 [array([[ 0.29868546,  0.49840906,  0.10026464]],
          dtype=float32), -0.20003042]
```

Now we can reuse the code with different inputs, and this division makes it easier to read, especially when it gets more complex.

In this example we called the main function twice with the same inputs and printed the variables that were created. Note that each call created a different set of variables, resulting in the creation of four variables. Let's assume, for example, a scenario where we wish to build a model with multiple inputs, such as two different images. Say we wish to apply the same convolutional filters to both input images. New variables will be created. To avoid this, we “share” the filter variables, using the same variables on both images.

## Variable sharing

It's possible to reuse the same variables by creating them with `tf.get_variable()` instead of `tf.Variable()`. We use this very similarly to `tf.Variable()`, except that we need to pass an initializer as an argument:

```
w = tf.get_variable('w',[1,3],initializer=tf.zeros_initializer())
b = tf.get_variable('b',[1,1],initializer=tf.zeros_initializer())
```

Here we used `tf.zeros_initializer()`. This initializer is very similar to `tf.zeros()`, except that it doesn't get the shape as an argument, but rather arranges the values according to the shape specified by `tf.get_variable()`.

In this example the variable `w` will be initialized as `[0,0,0]`, as specified by the given shape, `[1,3]`.

With `get_variable()` we can reuse variables that have the same name (including the scope prefix, which can be set by `tf.variable_scope()`). But first we need to indicate this intention by either using `tf.variable_scope.reuse_variable()` or setting

the reuse flag (`tf.variable.scope(reuse=True)`). An example of how to share variables is shown in the code that follows.



### Heads-up for flag misuse

Whenever a variable has the exact same name as another, an exception will be thrown when the reuse flag is not set. The same goes for the opposite scenario—variables with mismatching names that are expected to be reused (when `reuse = True`) will cause an exception as well.

Using these methods, and setting the scope prefix to `Regression`, by printing their names we can see that the same variables are reused:

```
def run_model(x_data,y_data):
    wb_ = []
    # Define placeholders and variables
    x = tf.placeholder(tf.float32,shape=[None,3])
    y_true = tf.placeholder(tf.float32,shape=None)

    w = tf.get_variable('w',[1,3],initializer=tf.zeros_initializer())
    b = tf.get_variable('b',[1,1],initializer=tf.zeros_initializer())

    print(b.name,w.name)

    # Form predictions
    y_pred = predict(x,y_true,w,b)

    # Create optimizer
    train = get_optimizer(y_pred,y_data)

    # Run session
    init = tf.global_variables_initializer()
    sess.run(init)
    for step in range(10):
        sess.run(train,{x: x_data, y_true: y_data})
        if (step % 5 == 4) or (step == 0):
            print(step, sess.run([w,b]))
            wb_.append(sess.run([w,b]))

    sess = tf.Session()

    with tf.variable_scope("Regression") as scope:
        run_model(x_data,y_data)
        scope.reuse_variables()
        run_model(x_data,y_data)
    sess.close()
```

The output is shown here:

```

Regression/b:0 Regression/w:0
0 [array([[ 0.27383861,  0.48421991,  0.09082422]],
          dtype=float32), array([[ -0.20805186]], dtype=float32)]
4 [array([[ 0.29868397,  0.49840903,  0.10026278]],
          dtype=float32), array([[ -0.20003076]], dtype=float32)]
9 [array([[ 0.29868546,  0.49840906,  0.10026464]],
          dtype=float32), array([[ -0.20003042]], dtype=float32)]

Regression/b:0 Regression/w:0
0 [array([[ 0.27383861,  0.48421991,  0.09082422]],
          dtype=float32), array([[ -0.20805186]], dtype=float32)]
4 [array([[ 0.29868397,  0.49840903,  0.10026278]],
          dtype=float32), array([[ -0.20003076]], dtype=float32)]
9 [array([[ 0.29868546,  0.49840906,  0.10026464]],
          dtype=float32), array([[ -0.20003042]], dtype=float32)]

```

`tf.get_variables()` is a neat, lightweight way to share variables. Another approach is to encapsulate our model as a class and manage the variables there. This approach has many other benefits, as described in the following section

## Class encapsulation

As with any other program, when things get more complex and the number of code lines grows, it becomes very convenient to have our TensorFlow code reside within a class, giving us quick access to methods and attributes that belong to the same model. Class encapsulation allows us to maintain the state of our variables and then perform various post-training tasks like forming predictions, model evaluation, further training, saving and restoring our weights, and whatever else is related to the specific problem our model solves.

In the next batch of code we see an example of a simple class wrapper. The model is created when the instance is instantiated, and the training process is performed by calling the `fit()` method.



### @property and Python decorators

This code uses a `@property` decorator. A *decorator* is simply a function that takes another function as input, does something with it (like adding some functionality), and returns it. In Python, a decorator is defined with the `@` symbol.

`@property` is a decorator used to handle access to class attributes.

Our class wrapper is as follows:

```

class Model:
    def __init__(self):
        # Model

```



```

self.x = tf.placeholder(tf.float32,shape=[None,3])
self.y_true = tf.placeholder(tf.float32,shape=None)
self.w = tf.Variable([[0,0,0]],dtype=tf.float32)
self.b = tf.Variable(0,dtype=tf.float32)

init = tf.global_variables_initializer()
self.sess = tf.Session()
self.sess.run(init)

self._output = None
self._optimizer = None
self._loss = None

def fit(self,x_data,y_data):
    print(self.b.name)

    for step in range(10):
        self.sess.run(self.optimizer,{self.x: x_data, self.y_true: y_data})
        if (step % 5 == 4) or (step == 0):
            print(step, self.sess.run([self.w,self.b]))

@property
def output(self):
    if not self._output:
        y_pred = tf.matmul(self.w,tf.transpose(self.x)) + self.b
        self._output = y_pred
    return self._output

@property
def loss(self):
    if not self._loss:
        error = tf.reduce_mean(tf.square(self.y_true-self.output))
        self._loss= error
    return self._loss

@property
def optimizer(self):
    if not self._optimizer:
        opt = tf.train.GradientDescentOptimizer(0.5)
        opt = opt.minimize(self.loss)
        self._optimizer = opt
    return self._optimizer

lin_reg = Model()
lin_reg.fit(x_data,y_data)
lin_reg.fit(x_data,y_data)

```

And we get this:

```
Variable_89:0
0 [array([[ 0.32110521,  0.4908163 ,  0.09833425]],
          dtype=float32), -0.18784374]
4 [array([[ 0.30250472,  0.49442694,  0.10041162]],
          dtype=float32), -0.1999902]
9 [array([[ 0.30250433,  0.49442688,  0.10041161]],
          dtype=float32), -0.19999036]

Variable_89:0
0 [array([[ 0.30250433,  0.49442688,  0.10041161]],
          dtype=float32), -0.19999038]
4 [array([[ 0.30250433,  0.49442688,  0.10041161]],
          dtype=float32), -0.19999038]
9 [array([[ 0.30250433,  0.49442688,  0.10041161]],
          dtype=float32), -0.19999036]
```

Splitting the code into functions is somewhat redundant in the sense that the same lines of code are recomputed with every call. One simple solution is to add a condition at the beginning of each function. In the next code iteration we will see an even nicer workaround.

In this setting there is no need to use variable sharing since the variables are kept as attributes of the model object. Also, after calling the training method `model.fit()` twice, we see that the variables have maintained their current state.

In our last batch of code for this section we add another enhancement, creating a custom decorator that automatically checks whether the function was already called.

Another improvement we can make is having all of our variables kept in a dictionary. This will allow us to keep track of our variables after each operation, as we saw in [Chapter 10](#) when we looked at saving weights and models.

Finally, additional functions for getting the values of the loss function and our weights are added:

```
class Model:
    def __init__(self):

        # Model
        self.x = tf.placeholder(tf.float32, shape=[None, 3])
        self.y_true = tf.placeholder(tf.float32, shape=None)

        self.params = self._initialize_weights()

        init = tf.global_variables_initializer()
        self.sess = tf.Session()
        self.sess.run(init)

        self.output
        self.optimizer
```

```

self.loss

def _initialize_weights(self):
    params = dict()
    params['w'] = tf.Variable([[0,0,0]],dtype=tf.float32)
    params['b'] = tf.Variable(0,dtype=tf.float32)
    return params

def fit(self,x_data,y_data):
    print(self.params['b'].name)

    for step in range(10):
        self.sess.run(self.optimizer,{self.x: x_data, self.y_true: y_data})
        if (step % 5 == 4) or (step == 0):
            print(step,
                  self.sess.run([self.params['w'],self.params['b']]))

def evaluate(self,x_data,y_data):
    print(self.params['b'].name)

    MSE = self.sess.run(self.loss,{self.x: x_data, self.y_true: y_data})
    return MSE

def getWeights(self):
    return self.sess.run([self.params['b']])

@property_with_check
def output(self):
    y_pred = tf.matmul(self.params['w'],tf.transpose(self.x)) + \
        self.params['b']
    return y_pred

@property_with_check
def loss(self):
    error = tf.reduce_mean(tf.square(self.y_true-self.output))
    return error

@property_with_check
def optimizer(self):
    opt = tf.train.GradientDescentOptimizer(0.5)
    opt = opt.minimize(self.loss)
    return opt

lin_reg = Model()
lin_reg.fit(x_data,y_data)
MSE = lin_reg.evaluate(x_data,y_data)
print(MSE)

print(lin_reg.getWeights())

```

Here is the output:

```
Variable_87:0
0 [array([[ 0.32110521,  0.4908163 ,  0.09833425]],
          dtype=float32), -0.18784374]
4 [array([[ 0.30250472,  0.49442694,  0.10041162]],
          dtype=float32), -0.1999902]
9 [array([[ 0.30250433,  0.49442688,  0.10041161]],
          dtype=float32), -0.19999036]

Variable_87:0
0 [array([[ 0.30250433,  0.49442688,  0.10041161]],
          dtype=float32), -0.19999038]
4 [array([[ 0.30250433,  0.49442688,  0.10041161]],
          dtype=float32), -0.19999038]
9 [array([[ 0.30250433,  0.49442688,  0.10041161]],
          dtype=float32), -0.19999036]

Variable_87:0
0.0102189
[-0.19999036]
```

The custom decorator checks whether an attribute exists, and if not, it sets it according to the input function. Otherwise, it returns the attribute. `functools.wrap()` is used so we can reference the name of the function:

```
import functools

def property_with_check(input_fn):
    attribute = '_cache_' + input_fn.__name__

    @property
    @functools.wraps(input_fn)
    def check_attr(self):
        if not hasattr(self, attribute):
            setattr(self, attribute, input_fn(self))
        return getattr(self, attribute)

    return check_attr
```

This was a fairly basic example of how we can improve the overall code for our model. This kind of optimization might be overkill for our simple linear regression example, but it will definitely be worth the effort for complicated models with plenty of layers, variables, and features.

## Customization

So far we've used two loss functions. In the classification example in [Chapter 2](#) we used the cross-entropy loss, defined as follows:

```
cross_entropy = tf.reduce_mean(
    tf.nn.softmax_cross_entropy_with_logits(logits=y_pred, labels=y_true))
```

In contrast, in the regression example in the previous section we used the square error loss, defined as follows:

```
loss = tf.reduce_mean(tf.square(y_true-y_pred))
```

These are the most commonly used loss functions in machine learning and deep learning right now. The purpose of this section is twofold. First, we want to point out the more general capabilities of TensorFlow in utilizing custom loss functions. Second, we will discuss regularization as a form of extension of any loss function in order to achieve a specific goal, irrespective of the basic loss function used.

## Homemade loss functions

This book (and presumably our readers) takes a specific view of TensorFlow with the aspect of deep learning in mind. However, TensorFlow is more general in scope, and most machine learning problems can be formulated in a way that TensorFlow can be used to solve. Furthermore, any computation that can be formulated in the computation graph framework is a good candidate to benefit from TensorFlow.

The predominant special case is the class of unconstrained optimization problems. These are extremely common throughout scientific (and algorithmic) computing, and for these, TensorFlow is especially helpful. The reason these problems stand out is that TensorFlow provides an automatic mechanism for computing gradients, which affords a tremendous speedup in development time for such problems.

In general, optimization with respect to an arbitrary loss function will be in the form

```
def my_loss_function(key-variables...):
    loss = ...
    return loss

my_loss = my_loss_function(key-variables...)
gd_step = tf.train.GradientDescentOptimizer().minimize(my_loss)
```

where any optimizer could be used in place of the GradientDescentOptimizer.

## Regularization

Regularization is the restriction of an optimization problem by imposing a penalty on the complexity of the solution (see the note in [Chapter 4](#) for more details). In this section we take a look at specific instances where the penalty is directly added to the basic loss function in an additive form.

For example, building on the softmax example from [Chapter 2](#), we have this:

```
x = tf.placeholder(tf.float32, [None, 784])
W = tf.Variable(tf.zeros([784, 10]))

y_true = tf.placeholder(tf.float32, [None, 10])
```

```

y_pred = tf.matmul(x, W)

cross_entropy = tf.reduce_mean(
    tf.nn.softmax_cross_entropy_with_logits(logits=y_pred, labels=y_true))

total_loss = cross_entropy + LAMBDA * tf.nn.l2_loss(W)

gd_step = tf.train.GradientDescentOptimizer(0.5).minimize(total_loss)

```

The difference between this and the original in [Chapter 2](#) is that we added `LAMBDA * tf.nn.l2_loss(W)` to the loss we are optimizing with respect to. In this case, using a small value of the trade-off parameter `LAMBDA` will have very little effect on the resulting accuracy (a large value will be detrimental). In large networks, where overfitting is a serious issue, this sort of regularization can often be a lifesaver.

Regularization of this sort can be done with respect to the weights of the model, as shown in the previous example (also called *weight decay*, since it will cause the weights to have smaller values), as well as to the activations of a specific layer, or indeed all layers.

Another factor is what function we use—we could have used `l1` instead of the `l2` regularization, or a combination of the two. All combinations of these regularizers are valid and used in various contexts.

Many of the abstraction layers make the application of regularization as easy as specifying the number of filters, or the activation function. In Keras (a very popular extension reviewed in [Chapter 7](#)), for instance, we are provided with the regularizers listed in [Table A-1](#), applicable to all the standard layers.

*Table A-1. Regularization with Keras*

Regularizer	What it does	Example
<code>l1</code>	<code>l1</code> regularization of weights	<code>Dense(100, W_regularizer=l1(0.01))</code>
<code>l2</code>	<code>l2</code> regularization of weights	<code>Dense(100, W_regularizer=l2(0.01))</code>
<code>l1l2</code>	Combined <code>l1</code> + <code>l2</code> regularization of weights	<code>Dense(100, W_regularizer=l1l2(0.01))</code>
<code>activity_l1</code>	<code>l1</code> regularization of activations	<code>Dense(100, activity_regularizer=activity_l1(0.01))</code>
<code>activity_l2</code>	<code>l2</code> regularization of activations	<code>Dense(100, activity_regularizer=activity_l2(0.01))</code>
<code>activity_l1l2</code>	Combined <code>l1</code> + <code>l2</code> regularization of activations	<code>Dense(100, activity_regularizer=activity_l1l2(0.01))</code>

Using these shortcuts makes it easy to test different regularization schemes when a model is overfitting.

## Writing your very own op

TensorFlow comes ready packed with a large number of native ops, ranging from standard arithmetic and logical operations to matrix operations, deep learning-specific functions, and more. When these are not enough, it is possible to extend the system by creating a new op. This is done in one of two ways:

- Writing a “from scratch” C++ version of the operation
- Writing Python code that combines existing ops and Python code to create the new one

We will spend the remainder of this section discussing the second option.

The main reason to construct a Python op is to utilize NumPy functionality in the context of a TensorFlow computational graph. For the sake of illustration, we will construct the regularization example from the previous section by using the NumPy multiplication function rather than the TensorFlow op:

```
import numpy as np

LAMBDA = 1e-5

def mul_lambda(val):
    return np.multiply(val, LAMBDA).astype(np.float32)
```

Note that this is done for the sake of illustration, and there is no special reason why anybody would want to use this instead of the native TensorFlow op. We use this oversimplified example in order to shift the focus to the details of the mechanism rather than the computation.

In order to use our new creation from within TensorFlow, we use the `py_func()` functionality:

```
tf.py_func(my_python_function, [input], [output_types])
```

In our case, this means we compute the total loss as follows:

```
total_loss = cross_entropy + \
    tf.py_func(mul_lambda, [tf.nn.l2_loss(W)], [tf.float32])[0]
```

Doing this, however, will not be enough. Recall that TensorFlow keeps track of the gradients of each of the ops in order to perform gradient-based training of our overall model. In order for this to work with the new Python-based op, we have to specify the gradient manually. This is done in two steps.

First, we create and register the gradient:

```
@tf.RegisterGradient("PyMulLambda")
def grad_mul_lambda(op, grad):
    return LAMBDA*grad
```

Next, when using the function, we point to this function as the gradient of the op. This is done using the string registered in the previous step:

```
with tf.get_default_graph().gradient_override_map({"PyFunc": "PyMuLLambda"}):
    total_loss = cross_entropy + \
        tf.py_func(mu_l_lambda, [tf.nn.l2_loss(W)], [tf.float32])[0]
```

Putting it all together, the code for the softmax model with regularization through our new Python-based op is now:

```
import numpy as np
import tensorflow as tf

LAMBDA = 1e-5

def mu_l_lambda(val):
    return np.multiply(val, LAMBDA).astype(np.float32)

@tf.RegisterGradient("PyMuLLambda")
def grad_mu_l_lambda(op, grad):
    return LAMBDA*grad

x = tf.placeholder(tf.float32, [None, 784])
W = tf.Variable(tf.zeros([784, 10]))

y_true = tf.placeholder(tf.float32, [None, 10])
y_pred = tf.matmul(x, W)

cross_entropy =
    tf.reduce_mean(tf.nn.softmax_cross_entropy_with_logits\
        (logits=y_pred, labels=y_true))

with tf.get_default_graph().gradient_override_map({"PyFunc": "PyMuLLambda"}):
    total_loss = cross_entropy + \
        tf.py_func(mu_l_lambda, [tf.nn.l2_loss(W)], [tf.float32])[0]

gd_step = tf.train.GradientDescentOptimizer(0.5).minimize(total_loss)

correct_mask = tf.equal(tf.argmax(y_pred, 1), tf.argmax(y_true, 1))
accuracy = tf.reduce_mean(tf.cast(correct_mask, tf.float32))
```

This can now be trained using the same code as in [Chapter 2](#), when this model was first introduced.





## Using the inputs in the computation of gradients

In the simple example we just showed, the gradient depends only on the gradient with respect to the input, and not on the input itself. In the general case, we will need access to the input as well. This is done easily, using the `op.inputs` field:

```
x = op.inputs[0]
```

Other inputs (if they exist) are accessed in the same way.

# Required and Recommended Components for TensorFlow Serving

In this section, we add details on some of the material covered in [Chapter 10](#) and review in more depth some of the technical components used behind the scenes in TensorFlow Serving.

In [Chapter 10](#), we used Docker to run TensorFlow Serving. Those who prefer to avoid using a Docker container need to have the following installed:

### *Bazel*

Bazel is Google's own build tool, which recently became publicly available. When we use the term *build*, we are referring to using a bunch of rules to create output software from source code in a very efficient and reliable manner. The build process can also be used to reference external dependencies that are required to build the outputs. Among other languages, Bazel can be used to build C++ applications, and we exploit this to build the C++-written TensorFlow Serving's programs. The source code Bazel builds upon is organized in a workspace directory inside nested hierarchies of packages, where each package groups related source files together. Every package consists of three types of files: human-written source files called *targets*, *generated files* created from the source files, and *rules* specifying the steps for deriving the outputs from the inputs.

Each package has a *BUILD* file, specifying the output to be built from the files inside that package. We use basic Bazel commands like `bazel build` to build generated files from targets, and `bazel run` to execute a build rule. We use the `-bin` flag when we want to specify the directories to contain the build outputs.

Downloads and installation instructions can be found on [the Bazel website](#).

### *gRPC*

Remote procedure call (RPC) is a form of client (caller)–server (executer) interaction; a program can request a procedure (for example, a method) that is executed on another computer (commonly in a shared network). gRPC is an open source framework developed by Google. Like any other RPC framework, gRPC lets you directly call methods on other machines, making it easier to distribute

the computations of an application. The greatness of gRPC lies in how it handles the serialization, using the fast and efficient protocol buffers instead of XML or other methods.

Downloads and installation instructions can be found [on GitHub](#).

Next, you need to make sure that the necessary dependencies for Serving are installed with the following command:

```
sudo apt-get update && sudo apt-get install -y \  
    build-essential \  
    curl \  
    libcurl3-dev \  
    git \  
    libfreetype6-dev \  
    libpng12-dev \  
    libzmq3-dev \  
    pkg-config \  
    python-dev \  
    python-numpy \  
    python-pip \  
    software-properties-common \  
    swig \  
    zip \  
    zlib1g-dev
```

And lastly, clone Serving:

```
git clone --recurse-submodules https://github.com/tensorflow/serving  
cd serving
```

As illustrated in [Chapter 10](#), another option is to use a Docker container, allowing a simple and clean installation.

## What Is a Docker Container and Why Do We Use It?

Docker is essentially solving the same problem as Vagrant with VirtualBox, and that is making sure our code will run smoothly on other machines. Different machines might have different operating systems as well as different tool sets (installed software, configurations, permissions, etc.). By replicating the same environment—maybe for production purposes, maybe just to share with others—we guarantee that our code will run exactly the same way elsewhere as on our original development machine.

What's unique about Docker is that, unlike other similarly purposed tools, it doesn't create a fully operational virtual machine on which the environment will be built, but rather creates a *container* on top of an existing system (Ubuntu, for example), acting as a virtual machine in a sense and using our existing OS resources. These containers are created from a local Docker *image*, which is built from a *dockerfile* and encapsulates everything we need (dependency installations, project code, etc.). From that

image we can create as many containers as we want (until we run out of memory, of course). This makes Docker a very cool tool with which we can easily create complete multiple environment replicas that contain our code and run them anywhere (very useful for cluster computing).

## Some Basic Docker Commands

To get you a bit more comfortable with using Docker, here's a quick look at some useful commands, written in their most simplified form. Given that we have a `dockerfile` ready, we can build an image by using `docker build <dockerfile>`. From that image we can then create a new container by using the `docker run <image>` command. This command will also automatically run the container and open a terminal (type `exit` to close the terminal). To run, stop, and delete existing containers, we use the `docker start <container id>`, `docker stop <container id>`, and `docker rm <container id>` commands, respectively. To see the list of all of our instances, both running and idle, we write `docker ps -a`.

When we run an instance, we can add the `-p` flag followed by a port for Docker to expose, and the `-v` flag followed by a home directory to be mounted, which will enable us to work locally (the home directory is addressed via the `/mnt/home` path in the container).



## Symbols

.assign(), 109, 182  
.compile(), 137  
.eval(), 35  
.evaluate(), 120  
.fit(), 119, 127, 133, 137  
.get\_variable\_value(), 127  
.meta checkpoint files, 188  
.name attribute, 37  
.optimizers, 137  
.run() method, 27  
.save(), 185  
.\_\_enter\_\_(), 28  
.\_\_exit\_\_(), 28  
<Estimator>.predict(), 122  
@property decorator, 208

## A

abstraction libraries  
  abstraction illustration, 113  
  benefits of, 8, 113  
  contrib.learn, 117-131  
  popular libraries, 115  
  regularization and, 214  
  TFLearn, 131-151  
acknowledgments, x  
activation functions, 56  
aliases, 11  
argparse module, 169  
arguments  
  callbacks, 138  
  feed\_dict argument, 20, 154  
  fetches argument, 29  
  ksize argument, 56

  num-epochs argument, 164  
  perm argument, 75  
  shape argument, 40  
  strides argument, 55  
arrays, 33-38  
.assign(), 109, 182  
asynchronous training, 169  
as\_default() command, 29  
attributes  
  .name, 37  
  <node>.graph attribute, 28  
  dtype, 32  
  purpose of, 31  
  setting with source operations, 31  
attributions, viii  
autoencoders, 139-142

## B

backpropagation, 6  
bag-of-words text classification, 96  
BasicRNNCell, 84  
batch\_size, 74  
Bazel build tool, 194, 200, 217  
between-graph replication, 171  
bias\_variable(), 58  
binary classification, 134  
biologically inspired models, 52

## C

callbacks argument, 138  
casting, 32  
chains, 71  
CIFAR10 dataset, 61-68  
class encapsulation, 208

- clusters, 170
- code examples, obtaining and using, viii
- command-line arguments, 169
- comments and questions, ix
- Common Crawl vectors, 106
- .compile(), 137
- computation graphs (see dataflow computation graphs)
- computer vision
  - pretrained models for, 3
  - sequence data and, 69
- confusion matrices, 122
- constructors, 31
- contact information, ix
- context managers, 28
- continuous (regression) learning, 19, 41, 117
- contrib library, 84, 136
- contrib.layers, 125, 128
- contrib.learn
  - built-in estimators, 117
  - custom CNN estimators, 128-131
  - deploying custom models, 117
  - DNN classifier, 120-122
  - feature transformation operations, 128
  - FeatureColumn, 123-128
  - importing, 117
  - linear regression, 118
  - overview of, 115
- contrib.learn.Estimator(), 130, 132
- conv2d(), 54, 58
- convolutional neural networks (CNNs)
  - architecture visualization, 58
  - CIFAR10 dataset classification, 61-68
  - convolution operation, 54, 60
  - creating models with TF-Slim, 144-151
  - custom estimators using contrib.learn, 128-131
  - MNIST dataset classification, 53-61
  - model creation using TFLearn, 131-134
  - overview of, 51-53
- conv\_layer(), 58
- coord.request\_stop(), 161
- coord.should\_stop(), 161
- cross entropy, 19, 42, 212
- customization
  - loss functions, 212
  - regularization, 213
  - TensorFlow Ops, 215

## D

- data augmentation, 67
- data frames (tables), 124
- data parallelism, 168
- data types
  - changing, 32
  - choosing explicitly, 32
  - default data format, 154
  - labeled vs. unlabeled data, 96
  - sequence data, 69
  - supported types, 33
  - type inference, 33
- dataflow computation graphs
  - benefits of, 24
  - constructing and managing, 27-29
  - creating, 25
  - fetches argument, 29
  - overview of, 5, 23
  - replicating across devices, 171
  - resetting prior to restoring, 188
  - session closing, 27
  - session creation, 26
- deactivate command, 11
- decorators, 208
- deep learning
  - advances in, 1
  - computer vision, 3, 69
  - data processing in, 5
  - image captioning, 3
  - overview of, 1
  - sequence data and, 70
  - supervised learning, 18, 19
  - unsupervised learning, 97
- deep learning models (see models)
- deep neural networks (see deep learning)
- dense vector representations, 96
- Dense(), 137
- dequeuing and enqueueing, 157
- design tips
  - class encapsulation, 208
  - model structure, 203
  - modular design, 205
  - variable sharing, 206
- device placement, 172
- digit\_to\_word\_map dictionary, 87
- dimensionality reduction, 139
- discrete (classification) learning, 19
- display\_cifar(), 64
- DistBelief, 2

- distributed computing
  - distributed example, 173-179
  - overview of, 167
  - parallelization and, 168
  - TensorFlow elements, 169-173
- distributional hypothesis, 97
- DNN classifier, 120-122
- Docker
  - alternatives to, 217
  - basic commands, 219
  - benefits of, 193, 218
  - container creation, 193
  - overview of, 218
  - setup, 193
- dropout, 57, 110
- DropoutWrapper(), 110
- dtype attribute, 32
- dynamic\_rnn(), 90, 92, 108, 110

## E

- early stopping, 138
- edge detectors, 52
- edges, 30
- elements (see TensorFlow elements)
- element\_size, 73
- embedding\_matrix, 109, 111
- embedding\_placeholder, 109, 111
- enqueueing and dequeuing, 157
- .\_\_enter\_\_(), 28
- estimators, 117
- .eval(), 35
- .evaluate(), 120
- .\_\_exit\_\_(), 28
- external data, 17

## F

- feature maps, 54
- feature\_columns, 120, 123-128
- feed\_dict argument, 20, 154
- fetches argument, 29
- filters
  - in CNNs, 51, 54
  - in human visual processing, 52
- .fit(), 119, 127, 133, 137
- flags mechanism, 169
- fully connected neural networks, 51
- full\_layer(), 58
- functools.wrap(), 212

## G

- gated recurrent unit (GRU) cells, 110
- get\_shape(), 34
- .get\_variable\_value(), 127
- global\_step, 178
- GloVe embedding method, 106
- gradient descent optimization, 6, 19, 42-44, 78, 101
- GradientDescentOptimizer(), 44
- graphs (see dataflow computation graphs)
- gRPC framework, 217
- GRUCell(), 110

## H

- h5py package, 142
- “hello world” program, 11-13
- helper functions, 57
- hidden layers, 139
- hidden Markov model (HMM), 71
- hidden\_layer\_size, 74

## I

- IDE configuration, 12
- image captioning, 3
- image classification
  - CIFAR10, 61-68
  - illustration of, 1
  - images as sequences, 72
  - invariance property, 52
  - MNIST, 13, 53-61
  - pretrained models for, 3
  - softmax regression, 14-20, 101, 165
- ImageNet project, 147
- IMDb reviews dataset, 134
- initializers, 34, 59, 111, 206
- input pipeline
  - full multithreaded, 162-166
  - overview of, 153
  - queues, 157-158
  - redesign of, 166
  - TFRecords, 154-157
- input\_data.read\_data\_sets(), 62
- input\_fn(), 127
- integer IDs, 95
- invariance, 52

## J

- JSON, 191

## K

- keep\_prob, 129
- Keras
  - autoencoders, 139-142
  - benefits of, 136
  - functional model, 138
  - installing, 136
  - overview of, 115
  - pre-trained models, 143
  - regularization with, 214
  - sequential model, 137
- ksize argument, 56

## L

- labeled data, 96
- lambda functions, 127
- language models, 70
- layers.convolution2d(), 128
- learn.LinearRegressor(), 119
- learning rates, 19, 44, 101
- learning\_rate hyperparameter, 101
- lifecycle management, 192
- linear regression, 44-46, 117
- loaded weights, assigning, 182
- local response normalization (LRN), 133
- logistic regression, 46-48, 117
- LOG\_DIR, 74, 79
- long short-term memory (LSTM), 89-93, 110
- loss functions
  - choosing, 41
  - cross entropy, 19, 42, 212
  - customizing, 213
  - Noise-Contrastive Estimation (NCE), 101
  - square error loss, 213

## M

- Markov chain model, 71
- Matplotlib, 63
- matrices, 33, 122
- matrix multiplication, 36
- max\_pool\_2x2, 58
- mean squared error (MSE), 41, 119
- memory errors, 21
  - .meta checkpoint files, 188
  - metadata files, 102
  - metainformation, 188
  - mini-batches, 43
  - MINIBATCH\_SIZE, 20

- MNIST (Mixed National Institute of Standards and Technology), 13, 53-61, 72-74
- model.fit(), 210
- Model.load\_weights(), 142
- models
  - biologically inspired, 52
  - CNN classification of CIFAR10 dataset, 64-68
  - CNN classification of MNIST dataset, 57-61
  - customizing loss functions, 212-217
  - evaluating, 20
  - language models, 70
  - measures of similarity in, 19, 42
  - optimizing, 40-48
  - pretrained, 3
  - regression, 41, 117
  - saving, 142
  - saving and exporting, 181-191
  - sequential model, 137
  - serving, 191-201
  - softmax regression, 14-20, 101, 165
  - structuring, 203-212
  - training, 19, 41, 59, 127, 134, 167
  - VGG model, 146
- MSE (mean squared error), 41, 119, 213
- multiple computational devices, 172
- MultiRNNCell(), 93
- multithreading
  - device placement and, 173
  - full input pipeline example, 162-166
  - queues and, 159

## N

- names and naming
  - duplicate names, 38
  - .name attribute, 37
  - name scopes, 38
- natural language processing (NLP), 95
- natural language understanding (NLU), 4, 70
- neuroscientific inspiration, 52
- nodes, 30
- Noise-Contrastive Estimation (NCE), 101
- normal distribution, 34
- normalization, 132, 133
- np.random.choice(range()), 85
- NumPy, 30, 33, 215
- num\_epochs argument, 164



## O

- objectives, 41
  - (see also loss function)
- operation instances, 30
- operators and shortcuts, 25
- ops, 215
- optimization
  - cross entropy loss, 19, 42, 212
  - gradient descent, 19, 42-44
  - linear regression example, 44-46, 117
  - logistic regression example, 46-48, 117
  - loss function, 41
  - MSE (mean squared error), 119, 213
  - MSE loss, 41
  - training to predict, 41
- optimizer.minimize(), 44
- .optimizers, 137
- overfitting, 53

## P

- padding, 55, 85
- PAD\_TOKEN, 108
- Pandas library, 124
- parallelization, 168, 171
- parameter servers, 170
- part-of-speech (POS) tagging, 110
- perm argument, 75
- placeholders
  - in CNNs, 60
  - example of, 40
  - purpose of, 39
  - shape argument, 40
- pooling, 56, 60
- pre-processing, 153
- pre-trained models, 3, 143-151
- principal component analysis (PCA), 139
- processed images, 54
- @property decorator, 208
- protocol buffers (protobufs), 154, 191
- PyCharm IDE, 12
- Python
  - argparse module, 169
  - CIFAR10 dataset version, 62
  - data types supported in TensorFlow, 33
  - decorators, 208
  - ops, 215
  - vs. TensorFlow programs, 11
  - Theano library, 116
  - with statements, 28

## Q

- qr.create\_threads(), 162
- questions and comments, ix
- queues
  - enqueueing and dequeuing, 157
  - multithreading, 159
  - vs. ordinary queues, 157
  - tf.train.Coordinator, 161
  - tf.train.QueueRunner, 162

## R

- random initializers, 34, 59
- read\_data\_sets() method, 18
- recurrent neural networks (RNNs)
  - basic implementation of, 72-81
  - bidirectional RNNs, 110
  - functions built into TensorFlow, 82-84
  - model creation using TFLearn, 134
  - overview of, 70
  - sequence data and, 69, 71
  - static vs. dynamic creation, 84
  - for text sequences, 84-93
- regression problems
  - linear, 44-46, 117
  - logistic, 46-48, 117
  - simple, 41
- regression(), 131
- regularization
  - definition of term, 53, 213
  - dropout, 57, 110
  - with Keras, 214
  - loss functions and, 213
- ReLU neurons, 133
- remote procedure call (RPC), 217
- RGB images, 5
- RMSPropOptimizer, 78
- rnn\_cell, 84
- rnn\_step(), 83
- .run() method, 27

## S

- sampling methods, 43
- .save(), 185
- saver.save(), 190
- save\_dir, 155
- saving and exporting, 181-191
  - assigning loaded weights, 182

- required and recommended components
  - for, 217
- resetting graphs prior to restore, 188
- Saver class, 185
- saving as a collection, 189
- serialization and protocol buffers, 191
- scalars, 32, 33, 80
- Scikit Flow, 115
- scikit-learn, 115
- sentiment analysis, 134
- sequence data, 69, 72
  - (see also text sequences)
- sequential model, 137
- serialization, 191
- servers, 170
- serving output in production, 191-201, 217-219
- sess.run() method, 29, 45
- session.run(), 40
- sessions
  - closing, 27
  - creating and running, 26
  - interactive, 35
  - managed, 171
  - pre- and post-run, 30
- shape argument, 40
- skip-grams, 97-100
- slim.assign\_from\_checkpoint\_fn(), 149
- softmax regression, 14-20, 101, 165
- source operations
  - descriptions of, 35
  - purpose of, 30, 32
- special method functions, 28
- square error loss, 41, 119, 213
- stochastic gradient descent (SGD), 43
- strides argument, 55
- supervised learning, 18, 19, 87
- Supervisor, 171
- synchronous training, 169

## T

- tanh(), 72
- tensor (mathematical term), 33
- TensorBoard
  - Embeddings tab, 104
  - functions of, 74
  - Graphs tab, 80
  - Histograms tab, 81
  - illustration of, 7
  - log verbosity, 132

- logging summaries, 74
- LOG\_DIR (directory), 74
- model visualization using, 79
- Scalars tab, 80
- tensorboard command, 80
- Word2vec training and visualization, 102
- TensorFlow
  - applications of by Google, 2-4
  - data types supported, 33
  - documentation, 101
  - history of, 2
  - IDE configuration, 12
  - installing, 9-11
  - key features, 6-8
  - main phases of operation, 24
  - naming of, 30
  - operators and shortcuts, 25, 35
  - prerequisites to learning, viii
- tensorflow command, 11
- TensorFlow elements,
  - clusters and servers, 170
  - device placement, 172
  - managed sessions, 171
  - replicating computational graphs, 171
  - tf.app.flags, 169
- TensorFlow ops, 215
- TensorFlow Serving
  - benefits of, 191
  - exporting models, 194-201
  - installing, 193
  - overview of, 192
  - required and recommended components
    - for, 217-219
  - workspace directory and packages, 194
- tensorflow.contrib.learn, 155
- Tensors
  - attributes, 31
  - basics of, 30
  - data types, 32
  - flowing data through, 30-38
    - data types, 32
    - names and naming, 37
    - nodes and edges, 30
    - tensor arrays and shapes, 33
  - names, 37
  - optimization, 40-48
  - placeholders, 39
  - purpose of, 5
  - Variables, 38

test(), 66  
 test\_accuracy, 60  
 text sequences
 

- natural language understanding and, 70
- RNN for, 84-93
- word embeddings and, 95, 105
- Word2vec and, 97-105

 text summarization, 4  
 TF-Slim
 

- available layer types, 145
- benefits of, 144
- creating CNN models with, 144
- overview of, 115
- pre-trained models, 147

 tf.<operator> methods, 25, 31, 35  
 tf.add(), 30  
 tf.app.flags, 169  
 tf.app.flags.FLAGS, 170  
 tf.cast(), 32  
 tf.concat(), 111  
 tf.constant(), 31, 32  
 tf.contrib.rnn.BasicLSTMCell(), 90  
 tf.contrib.rnn.BasicRNNCell, 82  
 tf.contrib.rnn.MultiRNNCell(), 93  
 tf.expand\_dims(), 37, 149  
 tf.get\_variables(), 39, 206  
 tf.global\_variables\_initializer(), 39, 111  
 tf.Graph(), 27  
 tf.InteractiveSession(), 35  
 tf.linspace(a, b, n), 35  
 tf.map\_fn(), 77  
 tf.matmul(A,B), 36  
 tf.nn.bidirectional\_dynamic\_rnn(), 110  
 tf.nn.dynamic\_rnn(), 82, 87, 90  
 tf.nn.embedding\_lookup(), 89, 100  
 tf.nn.nce\_loss(), 101  
 tf.random.normal(), 34  
 tf.RandomShuffleQueue, 162  
 tf.reduce\_mean(), 42  
 tf.reset\_default\_graph(), 188  
 tf.scan(), 75, 84  
 tf.Session, 26  
 tf.SparseTensor(), 126  
 tf.square(), 42  
 tf.summary.histogram(), 81  
 tf.TFRecordReader(), 164  
 tf.train.Coordinator, 161  
 tf.train.exponential\_decay(), 102  
 tf.train.import\_meta\_graph(), 189  
 tf.train.QueueRunner, 161  
 tf.train.replica\_device\_setter(), 171, 178  
 tf.train.Saver(), 185  
 tf.train.shuffle\_batch(), 164  
 tf.train.start\_queue\_runners(), 165  
 tf.train.string\_input\_producer(), 164  
 tf.transpose(), 37  
 tf.Variable(), 39, 206  
 tf.variable\_scope.reuse\_variable(), 206  
 tf.While, 84  
 tf.zeros\_initializer(), 206  
 TFLearn
 

- benefits of, 131
- custom CNN model creation, 131-134
- epochs and iteration in, 134
- installing, 131
- Keras extension for, 136-143
- local response normalization (LRN), 133
- overview of, 115
- pre-trained models with TF-Slim, 143-151
- RNN text classification using, 134
- standard operations, 132

 tflearn.data\_utils.pad\_sequences(), 134  
 tflearn.DNN(), 132  
 tflearn.embedding(), 135  
 TFRecords, 154  
 TFRecordWriter, 155  
 Theano, 116, 136  
 three-dimensional arrays, 33  
 time\_steps, 73  
 train/test validation, 19  
 train\_accuracy, 60  
 transformations, 128  
 truncated normal initializers, 34  
 TSV (tab-separated values), 102  
 tuning (see optimization)  
 type inference, 32, 33  
 typographical conventions, viii

## U

unconstrained optimization problems, 213  
 uniform initializers, 34  
 unpickle(), 63  
 unsupervised learning, 97

## V

Vagrant, 218  
 Variables
 

- initializing, 45

- purpose of, 38
- random number generators and, 34
- reusing, 39, 206
- storing in dictionaries, 210
- using, 39

vectors, 33

versioning, 192

VGG model, 146

virtual environments, 10, 218

VirtualBox, 218

visualizations, using TensorBoard, 7, 74, 102

## W

- weights, 51, 182
- weight\_variable(), 58
- Windows, 10
- with statements, 28
- word embeddings
  - bidirectional RNNs, 110
  - LSTM classifier, 91

- overview of, 95
- pretrained, 105-110
- RNN example, 89
- using Word2vec, 97-105

word vectors (see word embeddings)

Word2vec

- embeddings in TensorFlow, 100
- examining word vectors, 103
- learning rate decay, 101
- skip-grams, 98-100
- training and visualizing with TensorBoard, 102

workers, 170

## X

- XML, 191

## Z

- zero-padding, 85

## About the Authors

---

**Tom Hope** is an applied machine learning researcher and data scientist with extensive backgrounds in academia and industry. He has experience as a senior data scientist in large international corporate settings, leading data science and deep learning R&D teams across multiple domains including web mining, text analytics, computer vision, sales and marketing, IoT, financial forecasting, and large-scale manufacturing. Previously, he was at a successful ecommerce startup in its early days, leading data science R&D. He has also served as a data science consultant for major international companies and startups. His research in computer science, data mining, and statistics revolves around machine learning, deep learning, NLP, weak supervision, and time series.

**Yehezkel S. Resheff** is an applied researcher in the fields of machine learning and data mining. His graduate work at Hebrew University was centered around developing machine learning and deep learning methods for the analysis of data from wearable devices and the IoT. He has led research initiatives both in large companies and small startups, resulting in several patents and research papers. Currently, Yehezkel is involved in the development of next generation deep learning technologies, and is a consultant for companies pushing the boundaries of machine learning.

**Itay Lieder** is an applied researcher in machine learning and computational neuroscience. During his graduate work at Hebrew University, he developed computational methods for modeling low-level perception and applied them as a profiling tool for individuals with learning deficits. He has worked for large international corporations, leading innovative deep learning R&D in text analytics, web mining, financial records, and various other domains.

## Colophon

---

The animal on the cover of *Learning TensorFlow* is a Blue tilapia (*Oreochromis aureus*). This freshwater fish is also known as Israeli tilapia because of its origins in the Middle East and parts of Africa. It is part of the cichlidae family and has spread to many parts of the US.

Blue tilapia youths are a more muted gray in color than adults, and have a black spot on the rear of their dorsal fins. Adults are more colorful with hues of blue (hence their name), red, white, and silver/gray. Light blue to white appears on their bellies, while shades of red and pink appear near and on the borders of their spiny dorsal and caudal fins. Average lengths for adults is between five and eight inches, and weights are around five to six pounds.

Blue tilapia are mouthbrooders, with mothers carrying between 160 and 1,600 eggs in her mouth after fertilization. They will hatch in her mouth, which will remain their

home for about three weeks, going out only to feed. The mother will not eat the usual herbivorous diet or zooplankton for the days her brood are incubating.

Many of the animals on O'Reilly covers are endangered; all of them are important to the world. To learn more about how you can help, go to [animals.oreilly.com](http://animals.oreilly.com).

The cover image is from *Lydekker's Royal Natural History*. The cover fonts are URW Typewriter and Guardian Sans. The text font is Adobe Minion Pro; the heading font is Adobe Myriad Condensed; and the code font is Dalton Maag's Ubuntu Mono.